

Pricelist
2022 / Q2

memo

Contents

page 3 Terms of Sale
page 4 Limited Lifetime Warranty
page 5 Customer Service
page 6 Finishes Overview
page 8 Textiles Overview

page 12 Chord Tables

page 12 Personal Table
page 14 Side Table
page 16 Coffee Table

page 18 Chroma Seating

page 18 Lounge
page 20 Lounge Armless
page 22 Lounge Swivel
page 24 Ottoman

page 25 Ida

page 25 Ida

page 26 Kino

page 26 Kino

page 28 Maru Benches

page 28 Three Slat Bench, 3/4 Length
page 31 Three Slat Bench
page 34 Five Slat Bench
page 38 Seven Slat Bench

page 42 Penna Seating

page 42 Lounge

page 44 Penna Tables

page 44 Large Round
page 45 Obround
page 46 Small Round
page 47 Bar Table
page 48 Café Table
page 50 Meeting Table

page 52 Prose Seating

page 52 Side Chair with Arms
page 54 Plus Chair
page 56 Settee
page 58 Pull-Up Chair
page 60 Lounge
page 62 Loveseat

page 64 Prose Tables

page 64 Free-Standing End Table
page 65 Free-Standing Coffee Table

page 66 Rolo Seating

page 66 Lounge
page 68 Loveseat
page 70 Sofa

page 72 Rolo Tables

page 72 Side Table
page 73 Coffee Table

page 74 Materials & Finishes Schedules

page 74 Textiles Schedule
page 86 Corian Solid Surface Schedule
page 87 Leather Arm Wrap Colors for Chroma

Terms of Sale

Pricing Policy

All prices shown for products and accessories are manufacturer's suggested list price. Prices shown do not include appropriate taxes, crating (if applicable), storage and installation charges. Memo reserves the right to amend price lists, change designs, and discontinue or add models without prior notice. Price list of latest date supersedes and cancels all previous lists. All orders accepted are subject to prices upon receipt of order.

Payment Terms

Except as otherwise specified, all orders require a 50% deposit with the balance due with thirty (30) days from the invoice date. All payments are payable in U.S. dollars. Lead times start after the receipt of deposit. Payments not made by the due date may incur, at the sole discretion of Memo, a late payment service charge of 1.5% per month. All payments and deposits are non-refundable.

Changes and Cancellations

Customers will receive a written confirmation of pricing, credit terms and estimated completion date. Changes to orders or cancellations made after production has begun will carry extra charges based on expenses incurred.

Shipping

Memo list prices include standard cartoning and standard surface freight to any point within the 48 contiguous United States. For shipments to Alaska, Hawaii and International destinations, additional shipping and handling charges will apply. Additional freight charges will be provided at the time of quote, and freight surcharges may apply as a result of market conditions. Orders are shipped cartoned as standard. If crating is requested or required, additional charges will apply. For a schedule of crating charges, please consult page 06 of this pricelist.

Freight Claims

Product is shipped FOB Factory, freight prepaid and allowed via truck. The title of goods changes to the purchaser when merchandise leaves Memo's dock and any subsequent freight damage and all freight claims are the responsibility of the purchaser. All shipments are transferred to the transportation company in good condition.

Purchaser should inspect cartons and product upon receipt and note the condition and any damage or shortage on the Bill of Lading. The purchaser should file all claims of evident damage or product shortages with the freight company and request an inspection. Shipping cartons and packaging should be retained for carrier inspection and the damaged product should be kept in the receiving location. If the freight carrier will not perform the inspection, purchaser should prepare an affidavit; noting that the freight company refused to comply with an inspection - citing date and time.

Any concealed damage claims against Memo for apparent damages must be made by the purchaser in writing within seven (7) business days after delivery. Failure to do so shall constitute acceptance of the product and waiver of any apparent damages. Any relevant damage or shortages to blanket wrapped shipments must be noted on the Bill of Lading at the time of delivery.

Custom Requests

Requests to modify existing products (Modifications) or to produce ground-up solutions (Specials) should be submitted to our customer service group, at which time they will be assessed and submitted for design and engineering approval. All custom requests will elicit a receipt and a response will be provided within 48 hours of receipt. Upon approval, a price and lead-time quote will be generated and provided for customer review and acceptance.

Limited Lifetime Warranty

Memo Furniture warrants its products, to the original user and for the original purpose, to be free of defects in design, material and workmanship, given normal use and care for the lifetime of the product from the date of invoice. This warranty does not include damage from accident, alteration, misuse, normal wear and tear, transportation or improper installation and maintenance.

During the warranty period, Memo Furniture, at its option, will repair or replace any product which, upon inspection by Memo Furniture or its designated representative, is deemed to be defective in materials or workmanship and is covered by this warranty.

This warranty does not apply to defects in components not manufactured by Memo Furniture. In these cases, the warranty period provided by the supplier of the component will apply. The liability of Memo Furniture is limited to furnishing new parts as may be necessary to replace any item that may prove to be defective in material or workmanship. Memo Furniture will make every effort to replace parts if they are available from the supplier of those parts. We will not assume liability of charges for labor, consequential expenses or damages incurred.

Textiles and leathers are not warranted against fading or normal wear, customer induced cuts or tears or irregularities in the registration of printed textile patterns. Due to natural variations, in which Memo Furniture has no control, this warranty does not extend to color, grain, texture or the durability or suitability of any exterior surface coatings or treatments.

This warranty is void in cases of damage in transit, negligence, abuse, abnormal usage, misuse, accidents, and improper cleaning and maintenance. Normal aging and wear of woven and non-woven upholstery are exempt from this warranty.

All other warranties, expressed or implied, are excluded. Memo Furniture shall not be liable for incidental or consequential damages of any sort.

If you have any questions or wish to file a claim against this warranty, please contact Customer Service at +1 206 995 8780.

Customer Service

Memo's Customer Service Group is trained to assist with quotes, orders, custom requests, product details, warranty inquiries, and to answer general questions.

We can be reached Monday through Friday, 7:00 am – 5:00 pm Pacific Time, directly at +1 206 995 8780 or via email at info@memofurniture.com.

Inquiries received after-hours via voicemail or email will receive a response before the close of business on the following business day.

Please visit www.memofurniture.com for answers to most questions including product prices, specifications, photos, SketchUp and Revit files, and marketing material. Additionally, a local sales representative can assist you further. Contact names and numbers are also available on our website.

Finishes

Memo offers a range of proprietary colors and finishes on select materials, as well as support for a broad range of open line laminates and solid surface. Our finishes have been curated to offer a foundation of essential base neutrals, to which accents and stronger colors can be added.

Memo offers finish and pattern selections in the following materials:

Forbo Furniture Linoleum

Memo offers Forbo furniture-grade linoleum on select products. Forbo is a durable surface material, available in a dynamic range of colors. Derived from solidified Linseed Oil and other natural fillers such as cork and wood dust, Forbo is a sustainable and resilient surface choice.

Metal Powder Coat

Our powder coats are applied to both steel and aluminum, and are available in textured and smooth finishes. Powder coating is extremely durable and emits zero pollutants once cured.

Natural Stone and Quartz

Memo offers natural stone and quartz on select table and horizontal surface tops. Our stone is hand selected from the highest quality slabs however natural variances will occur from product to product.

Solid Surface

Memo offers Corian and Wilsonart solid surface options on certain products. Solid Surface, is a non-porous high durability product that is stain resistant, easy to clean, and easily repairable.

Wood & Veneer

Our products utilize both solid wood and wood veneer, and are offered in either Ash, Beech or Walnut depending on the product. Products with edge profiles will include a matching wood edge. Wood products are finished in a resilient, long lasting, conversion varnish.

Memo Colors and Finishes

Metal Powder Coat

Light Gray Texture	MLG
Steel Gray Gloss	MSG
Med Bronze Gloss	MMB
Black Texture	MBT
Silver Metallic Gloss	MSM
Yellow Leaf Gloss	MYL
Copper Red Matte	MCR
Sage Green Matte	MGG
Navy Blue Matte	MNB

Natural Stone

White Gray Marble	RWM
-------------------	-----

Solid Surface (Wilsonart)

Black Onyx Mirage	STS-BLS
Hidden Spaces	STS-HIS
Kimberlite	STS-KIS
Yukon Riverstone	STS-YUS

Wood & Veneer

Clear over Ash	WCA
Oak Over Ash	WOA
Gray Over Ash	WGA
Walnut Over Ash	WWA
Clear Over Beech	WCB
Clear Over Walnut	WCW
Navy Painted Wood	WNP

Forbo Furniture Linoleum

Aquavert - 4180	FAQ
Ash - 4132	FAS
Burgundy - 4154	FBU
Charcoal - 4166	FCH
Iron - 4178	FIR
Midnight Blue - 4181	FMB
Mushroom - 4176	FMU
Olive - 4184	FOL
Pebble - 4175	FPE
Pewter - 4155	FPW
Powder - 4185	FPO
Salsa - 4164	FSA
Smokey Blue - 4179	FSB
Vapour - 4177	FVA

Memo Supported Open-Line Finishes

Corian

Memo offers open line Corian solid surface options on the Prose Collection. For a list of Corian products by grade see page 88.

Textiles

Graded-in Textiles

Memo has partnered with Kvadrat and Maharam to offer graded-in textiles. All graded-in textiles are listed by Pattern Name on page 77 and by Grading Group on page 82. Our Grading Groups and their LIST prices per yard are outlined below. Published product prices, including the cost of Graded-in Textiles, have been calculated by multiplying by the price per yard figures below by the yardage requirements indicated on a given product page.

Grading Group	LIST Price per Yard
1	52
2	65
3	81
4	92
5	106
6	119
7	138
8	163
9	188
10	219
11	256
12	294
13	375
14	438
15	563

Memo is glad to grade in textiles from suppliers other than Kvadrat and Maharam, per customer requests. A grading fee of \$200 NET per pattern will apply in such cases. Please contact us to submit grading requests.

When specifying graded-in textiles the projected completion date of your order may exceed our normal lead times due to constraints of the textile supplier. In such instances, Memo will promptly communicate such delays and advise on adjusted lead times.

Textiles are subject to the quality and shipping standards of the provider. Memo assumes no responsibility for defects, color inaccuracies, shortages, wear, or performance of textiles.

Ordering a Textile Sample

Samples can be ordered by visiting the textile provider's website.

Textiles

Customer's Own Material (COM)

While we recommend selecting from our graded-in Kvadrat and Maharam textile offer for the most streamlined process, we also provide the option to use COM. Memo, however, reserves the right to reject textiles which are unsuitable for upholstery on our products. This may be due to inadequate textile weight or unique elastic qualities which impact the integrity of upholstery on our products.

To select fabric outside of the graded-in fabric program, a few steps are required. Memo provides the total yardage for each product on its product spec sheets and pricelist reference pages. These published yardage figures are based on the application conditions of the cutting pattern for each product as well as managing quality issues. Certain textiles, depending on their width and/or repeat, may require additional yardage beyond the figures in our pricing pages. To calculate additional yardage, see our guidelines on page 11. Memo will also provide yardage requirements upon receipt of an order.

Upon receipt of the textile, Memo will immediately advise if flaws or deficiencies in the order are discovered. Memo assumes no responsibility for defects, color inaccuracies, shortages, wear, or sub-standard performance of the specified textiles.

Note that Memo will dispose of excess upholstery material at the time of shipment unless expressly requested to return it with the product shipment.

Customer's Own Leather (COL)

Please contact our customer service group at info@memofurniture.com or +1 206 995 8780.

Textiles**Delivery of Customer's Own Material (COM)**

Customers are responsible for ensuring delivery of COM fabric to Memo. Orders for COM-upholstered products will be scheduled into production upon receipt of all COM and swatches. Please work with our customer service group to procure written confirmation of textile supplier ship dates to ensure the best possible lead time. Since shipment of COM orders depends upon textile availability, lead times may vary.

When supplying COM textiles to Memo, please include the following info:

Textile supplier

Pattern name and number

Color name and number

A representative fabric swatch for identification purposes with face side marked

Any nonstandard treatments applied to the fabric

Any additional documentation

All COM or COL must be sent prepaid to the following address and tagged as follows:

Kaas Tailored c/o Memo Furniture

13000 Beverly Park Road, Suite A

Mukilteo, WA 98275

Attn: Receiving Department

Dealer name

P.O. #

Order code # (for each fabric)

Textiles

Order Requirements for Customer's Own Material (COM)

Memo reserves the right to reject textiles or materials. Textiles requiring secondary backing or coatings should be treated prior to shipping to Memo. All yardage figures listed in Memo product spec sheets and pricelist reference pages are based on at least 54" Wide, Plain Fabric.

Increases for Textile Width and/or Repeat

In the event that COM textile is both less than 54" wide and also has a repeat, add both of the two increases shown below. For textiles that require matching (stripes, plaids, prints, pattern repeats) it is Memo's policy to match all pattern repeats, stripes, prints or plaids unless specified 'No Matching Required' on purchase order.

Fabric Bolts Less than 54" Wide

Less than 54" wide	Add 08%
Less than 50" wide	Add 13%
Less than 48" wide	Add 20%
Less than 45" wide	Add 50%
Less than 36" wide	Add 60%

Fabrics with Repeats

Repeat 7" & less	Add 11%
Repeat 13" & less	Add 18%
Repeat 21" & less	Add 21%
Repeat 27" & less	Add 24%
Repeat more than 27"	Add 25%

Order Requirements for Customer's Own Leather (COL)

COL orders are based on an average hide size of 45 square feet of usable leather and 19 feet per yard. Due to shape and quality issues with some leather, additional hides may be required after receipt of COL. Ship full hides only.

To convert COM yardage requirements to COL square footage and number of hides, multiply the COM yardage by 19.

Example: 5 yards x 19 = 95 square feet.

Chord

Personal Table

Designed by Standard Issue, 2019

Made in the USA.

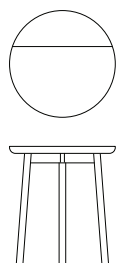

Depth	Width	Height
18"	18"	20.5"

Core Product	Core Code	List Price
Personal Table	MM01-T1	1344

Standard with Core Product

- Glides
- Open Tray Surface
- Powder Coated Steel Frame

Options

	Code	List Price Add
Large Insert Options		
Forbo Linoleum	FTL	304
Wood Veneer (Ash)	VAL	281
Clear Finish	WCA/WCW	0
Stain Finish	WOA/WWA/WGA/WNP	38
Wood Veneer (Walnut)	VWL	281
Small Insert Options		
No Insert (void)	XXS	0
Forbo Linoleum	FTS	57
Wood Veneer (Ash)	VAS	95
Clear Finish	WCA/WCW	0
Stain Finish	WOA/WWA/WGA/WNP	38
Wood Veneer (Walnut)	VWS	95
Solid Surface		
Yukon Riverstone	STS-YUS	562
Black Onyx Mirage	STS-BLS	562
Hidden Space	STS-HIS	562
Kimberlite	STS-KIS	674

Specifiable Finishes

Linoleum	Choose from Forbo linoleum products on page 7
Metal	Choose from Memo Metal Powder Coat Finishes on page 7
Wood	Choose from Memo Wood Finishes on page 7
Solid Surface	Choose from Memo Solid Surface Finishes on page 7

Notes

Pricing includes Freight within Continental US

For step-by-step specifications and quotes, access our live quote tool online at → [Quotes](#)

Chord

Side Table

Designed by Standard Issue, 2019

Made in the USA.

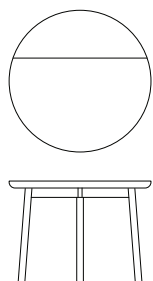

Depth	Width	Height
24"	24"	17.25"

Core Product

Side Table

Core Code

MM01-T2

List Price

1474

Standard with Core Product

Glides

Open Tray Surface

Powder Coated Steel Frame

Options

	Code	List Price Add
Large Insert Options		
Forbo Linoleum	FTL	354
Wood Veneer (Ash)	VAL	351
Clear Finish	WCA/WCW	0
Stain Finish	WOA/WWA/WGA/WNP	57
Wood Veneer (Walnut)	VWL	351
Small Insert Options		
No Insert (void)	XXS	0
Forbo Linoleum	FTS	58
Wood Veneer (Ash)	VAS	98
Clear Finish	WCA/WCW	0
Stain Finish	WOA/WWA/WGA/WNP	57
Wood Veneer (Walnut)	VWS	98
Solid Surface		
Yukon Riverstone	STS-YUS	649
Black Onyx Mirage	STS-BLS	649
Hidden Space	STS-HIS	649
Kimberlite	STS-KIS	792

Specifiable Finishes

Linoleum	Choose from Forbo linoleum products on page 7
Metal	Choose from Memo Metal Powder Coat Finishes on page 7
Wood	Choose from Memo Wood Finishes on page 7
Solid Surface	Choose from Memo Solid Surface Finishes on page 7

Notes

Pricing includes Freight within Continental US

For step-by-step specifications and quotes, access our live quote tool online at → [Quotes](#)

Chord

Coffee Table

Designed by Standard Issue, 2019

Made in the USA.

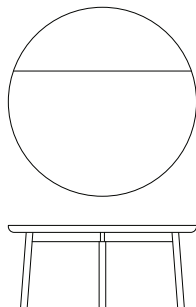

Depth	Width	Height
32"	32"	14.25"

Core Product

Coffee Table

Core Code

MM01-T3

List Price

1690

Standard with Core Product

Glides

Open Tray Surface

Powder Coated Steel Frame

Options

	Code	List Price Add
Large Insert Options		
Forbo Linoleum	FTL	445
Wood Veneer (Ash)	VAL	461
Clear Finish	WCA/WCW	0
Stain Finish	WOA/WWA/WGA/WNP	76
Wood Veneer (Walnut)	VWL	461
Small Insert Options		
No Insert (void)	XXS	0
Forbo Linoleum	FTS	71
Wood Veneer (Ash)	VAS	106
Clear Finish	WCA/WCW	0
Stain Finish	WOA/WWA/WGA/WNP	76
Wood Veneer (Walnut)	VWS	106
Solid Surface		
Yukon Riverstone	STS-YUS	735
Black Onyx Mirage	STS-BLS	735
Hidden Space	STS-HIS	735
Kimberlite	STS-KIS	904

Specifiable Finishes

Linoleum	Choose from Forbo linoleum products on page 7
Metal	Choose from Memo Metal Powder Coat Finishes on page 7
Wood	Choose from Memo Wood Finishes on page 7
Solid Surface	Choose from Memo Solid Surface Finishes on page 7

Notes

Pricing includes Freight within Continental US

For step-by-step specifications and quotes, access our live quote tool online at → [Quotes](#)

Chroma

Lounge

Designed by Harri Koskinen, 2019

Made in the USA.

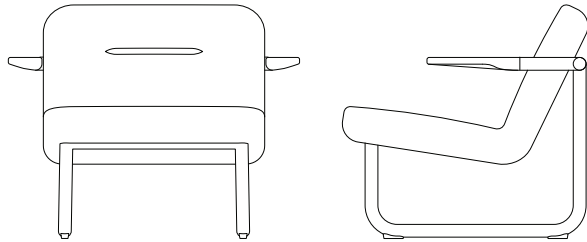

Depth	Width	Height
28.75"	33.75"	27.5"

Core Product

Lounge

Core Code

HK01-01

Textile Yardage

Total: 2.0

Seat Back Arms

n/a n/a n/a

List Price by Textile Grade

	COM / 1	2	3	4	5	6	7	8	9	10	11	12	13	14	15
HK01-01	3326	3352	3384	3406	3436	3460	3498	3548	3598	3660	3734	3810	3972	4098	4348

Standard with Core Product

Ash Arms

Non-Marring Glides

High Resilience Polyurethane Foam

Options and Notes overleaf

Options

Component	Code	List Price Add
Ash Arms with Stain	WOA/WWA/WGA/WNP	57
Walnut Arms	WCW	179

Specifiable Finishes

- Metal Choose from Memo Metal Powder Coat Finishes on page 7
- Textiles Choose from Maharam or Kvadrat textiles on page 74, or contact Memo for assistance with COM fabrics
- Wood Choose from Memo Wood Finishes on page 7

Notes

Pricing includes Freight within Continental US
Due to the continuous seat and back, multiple textiles are not permitted on Chroma Lounge
For step-by-step specifications and quotes, access our live quote tool online at → [Quotes](#)

Chroma

Lounge, Armless

Designed by Harri Koskinen, 2019

Made in the USA.

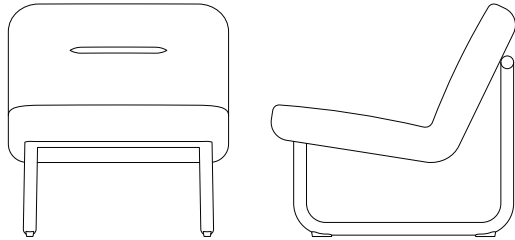

Depth	Width	Height
28.75"	26"	27.5"

Core Product

Lounge, Armless

Core Code

HK01-09

Textile Yardage

Total: 2.0

Seat Back Arms

n/a n/a n/a

List Price by Textile Grade

	COM / 1	2	3	4	5	6	7	8	9	10	11	12	13	14	15
HK01-09	3166	3192	3224	3246	3276	3300	3338	3388	3438	3500	3574	3650	3812	3938	4188

Standard with Core Product

Non-Marring Glides

High Resilience Polyurethane Foam

Options and Notes overleaf

Specifiable Finishes

- Metal Choose from Memo Metal Powder Coat Finishes on page 7
- Textiles Choose from Maharam or Kvadrat textiles on page 74, or contact Memo for assistance with COM fabrics

Notes

Pricing includes Freight within Continental US

Due to the continuous seat and back, multiple textiles are not permitted on Chroma Lounge

For step-by-step specifications and quotes, access our live quote tool online at → [Quotes](#)

Chroma

Lounge, Swivel

Designed by Harri Koskinen, 2019

Made in the USA.

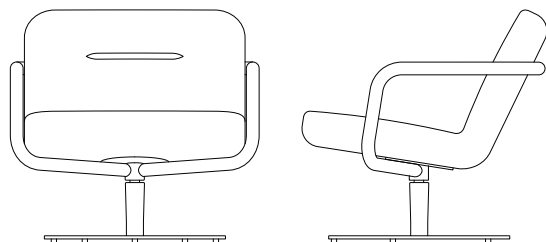

Depth	Width	Height
28.75"	29.25"	27.5"

Core Product

Lounge, Swivel

Core Code

HK01-11

Textile Yardage

Total: 2.0

Seat	Back	Arms
n/a	n/a	n/a

List Price by Textile Grade

	COM / 1	2	3	4	5	6	7	8	9	10	11	12	13	14	15
HK01-11	3371	3397	3429	3451	3481	3505	3543	3593	3643	3705	3779	3855	4017	4143	4393

Standard with Core Product

Free swivel base

High Resilience Polyurethane Foam

Non-Marring Glides

Options and Notes overleaf

Specifiable Finishes

Metal	Choose from Memo Metal Powder Coat Finishes on page 7
Textiles	Choose from Maharam or Kvadrat textiles on page 74, or contact Memo for assistance with COM fabrics

Notes

Pricing includes Freight within Continental US

Due to the continuous seat and back, multiple textiles are not permitted on Chroma Lounge

For step-by-step specifications and quotes, access our live quote tool online at → [Quotes](#)

Chroma

Ottoman - 17

Designed by Harri Koskinen, 2019

Made in the USA.

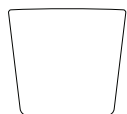
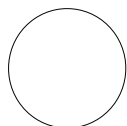

Depth	Width	Height
17.25"	17.25"	15.5"

Core Product

Ottoman

Core Code

HK01-00

Textile Yardage	Seat	Back	Arms
Total: 1.25	1.25	n/a	n/a

List Price by Textile Grade

	COM / 1	2	3	4	5	6	7	8	9	10	11	12	13	14	15
HK01-00	1028	1044	1064	1078	1097	1112	1136	1167	1198	1237	1283	1331	1461	1511	1667

Standard with Core Product

High Resilience Polyurethane Foam

Non-Marring Glides

Specifiable Finishes

Textiles Choose from Maharam or Kvadrat textiles on page 74, or contact Memo for assistance with COM fabrics

Notes

Pricing includes Freight within Continental US

For step-by-step specifications and quotes, access our live quote tool online at → Quotes

Chroma

Ottoman - 24

Designed by Harri Koskinen, 2019

Made in the USA.

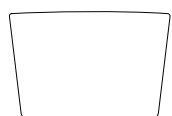
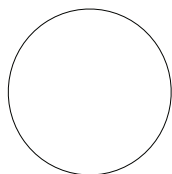

Depth	Width	Height
24"	24"	15.5"

Core Product

Ottoman

Core Code

HK01-24

Textile Yardage	Seat	Back	Arms
Total: 1.75	1.75	n/a	n/a

List Price by Textile Grade

	COM / 1	2	3	4	5	6	7	8	9	10	11	12	13	14	15
HK01-24	1342	1365	1393	1412	1438	1459	1493	1536	1580	1634	1699	1766	1907	2018	2236

Standard with Core Product

High Resilience Polyurethane Foam

Non-Marring Glides

Specifiable Finishes

Textiles Choose from Maharam or Kvadrat textiles on page 74, or contact Memo for assistance with COM fabrics

Notes

Pricing includes Freight within Continental US

For step-by-step specifications and quotes, access our live quote tool online at → Quotes

Chroma

Ottoman - 29

Designed by Harri Koskinen, 2019

Made in the USA.

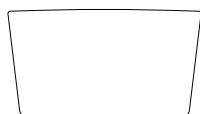
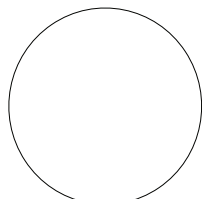

Depth	Width	Height
29"	29"	15.5"

Core Product

Ottoman

Core Code

HK01-29

Textile Yardage

Total: 2.25

Seat	Back	Arms
2.25	n/a	n/a

List Price by Textile Grade

	COM / 1	2	3	4	5	6	7	8	9	10	11	12	13	14	15
HK01-29	1715	1744	1780	1805	1839	1866	1909	1965	2021	2091	2174	2260	2442	2584	2865

Standard with Core Product

High Resilience Polyurethane Foam

Non-Marring Glides

Specifiable Finishes

Textiles Choose from Maharam or Kvadrat textiles on page 74, or contact Memo for assistance with COM fabrics

Notes

Pricing includes Freight within Continental US

For step-by-step specifications and quotes, access our live quote tool online at → Quotes

Chroma

Ottoman - 38

Designed by Harri Koskinen, 2019

Made in the USA.

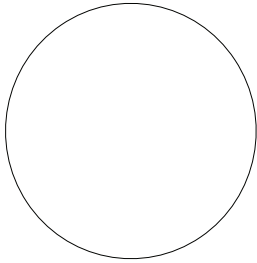

Depth	Width	Height
38"	38"	15.5"

Core Product

Ottoman

Core Code

HK01-38

Textile Yardage

Total: 3.5

Seat Back Arms

3.5 n/a n/a

List Price by Textile Grade

	COM / 1	2	3	4	5	6	7	8	9	10	11	12	13	14	15
HK01-38	2327	2373	2429	2467	2520	2562	2628	2716	2803	2912	3041	3174	3458	3678	4116

Standard with Core Product

High Resilience Polyurethane Foam

Non-Marring Glides

Specifiable Finishes

Textiles

Choose from Maharam or Kvadrat textiles on page 74, or contact Memo for assistance with COM fabrics

Notes

Pricing includes Freight within Continental US

For step-by-step specifications and quotes, access our live quote tool online at → Quotes

Ida

Table

Designed by Nina Cho, 2022

Made in the USA.

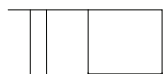
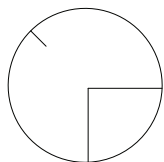

Depth	Width	Height
32"	32"	13.75"

Core Product	Core Code	List Price
Table	NC01-T1	4,961

Options

	Code	List Price Add
Shelf Insert Options		
No Shelf Insert	XXS	0
Solid Wood Insert (Ash)	WAS	288
Solid Wood Insert (Ash + Stain)	WOA/WWA/WGA/WNP	396
Solid Wood Insert (Walnut)	WWS	432
Stone Insert (Marble)	STS	1,060

Specifiable Finishes

Metal	Choose from Memo Metal Powder Coat Finishes on page 7
Wood (shelf)	Choose from Memo Wood Finishes on page 7

Notes

Pricing includes Freight within Continental US

For step-by-step specifications and quotes, access our live quote tool online at → Quotes

Kino

Stool

Designed by Kensaku Oshiro, 2020

Made in the Canada, Assembled in the USA.

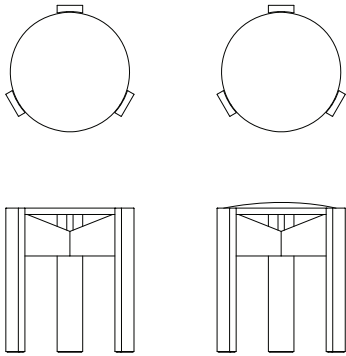

Depth	Width	Height
15.75"	15.75"	17.75 / 18.25"

Core Product	Core Code	List Price
Stool - Ash	KN01-S1-A	752
Stool - Walnut	KN01-S1-W	936

Standard with Core Product

- Glides
- Solid Wood Frame
- Solid Wood Top

Textile Yardage	Seat
Total: .75	.75

List Price by Textile Grade*

	COM / 1	2	3	4	5	6	7	8	9	10	11	12	13	14	15
KN01-S1-A-UTT	981	991	1003	1011	1022	1031	1046	1064	1083	1106	1134	1163	1223	1271	1364
KN01-S1-W-UTT	1123	1133	1145	1153	1164	1173	1188	1206	1225	1248	1276	1305	1365	1413	1506

Standard with Core Product

- Non-Marring Glides
- High Resilience Polyurethane Foam

Options and Notes overleaf

Options

	Code	List Price Add
Upholstered Top	UTT	See previous page
Forbo Linoleum Top with Wood Edge	FTT	235
Clear Finish (by species)	WCA/WCW	0
Stain Finish	WOA/WWA/WGA/WNP	76

Specifiable Finishes

- Wood Choose from Memo Wood Finishes on Page 7
- Textiles Choose from Maharam or Kvadrat textiles on page 74, or contact Memo for assistance with COM fabrics
- Linoleum Choose from Forbo linoleum products on page 7

Notes

Pricing includes Freight within Continental US
For step-by-step specifications and quotes, access our live quote tool online at → [Quotes](#)

Maru Benches

Three Slat Bench - 3/4-Length, Indoor

Designed by Studio Gorm, 2020

Made in the USA.



Depth	Width	Height
17.75"	65.5"	17"

Core Product

Three Slat Bench - 3/4-Length - Beech, Indoor

Core Code

SG03-IND-S3-66W-B

Standard with Core Product

Glides

Solid Beech Wood Frame

Upholstery Configurations

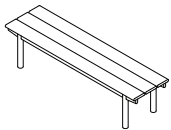

Configuration 1.3-S
(none)

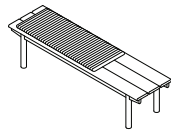

Configuration 2.3-S
-PC2

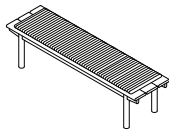

Configuration 3.3-S
-P60D2

Textile Yardage

Pad, Long (60"): 2.50 (each)

Pad, Standard: 1.50 (each)

Upholstery Configurations - List Price by Textile Grade

	Base	COM / 1	2	3	4	5	6	7	8	9	10	11	12	13	14	15
Configuration 1.3-S	2173	n/a	n/a	n/a	n/a	n/a	n/a	n/a	n/a	n/a	n/a	n/a	n/a	n/a	n/a	n/a
Configuration 2.3-S		2854	2873	2897	2914	2936	2954	2983	3020	3058	3104	3160	3217	3338	3433	3620
Configuration 3.3-S		2959	2992	3032	3059	3097	3127	3174	3581	3643	3377	3469	3564	3767	3924	4237

Options and Notes overleaf

Options

Wood Species	Code	List Price Add
Beech	B	0
Ash	A	390
Walnut	W	2891

Wood Finishes

Clear over Beech/Ash/Walnut	WCB/WCA/WCW	0
Ash with Stain Finish	WGA/WOA/WWQ/WNP	252

Accessories (see below for visuals)

Table, Round	T1	426
Table, Obround	T2	524
Power Module/s	PM1/PM2	273/795

Other Options

Veneer Table Top(s), Beech	VTB	0
Veneer Table Top(s), Ash	VTA	28
Veneer Table Top(s), Walnut	VTW	36
Forbo Linoleum Table Top(s)	FTT	127
Veneer Table Top(s), Ash with Stain	WGA/WOA/WWQ/WNP	60

Specifiable Finishes

- Linoleum Choose from Forbo linoleum products on page 7
- Textiles Choose from Maharam or Kvadrat textiles on page 74, or contact Memo for assistance with COM fabrics
- Wood/Veneer Choose from Memo Wood Finishes on page 7

Accessories (visuals)

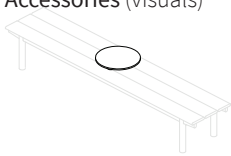

Table, Round
See below for locations

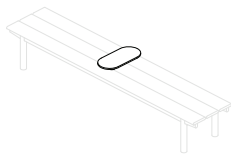

Table, Obround
See below for locations

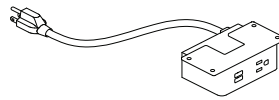

Power Module
1-Power, 2-USB

Table Locations (Round Table shown)

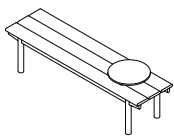

-T1F2
For Configurations 1.3-S

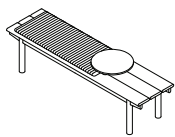

-T1E2
For Configuration 2.3-S

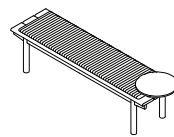

-T1G2
For Configuration 3.3-S

Notes overleaf

Notes

Pricing includes Freight within Continental US

For step-by-step specifications and quotes, access our live quote tool online at → [Quotes](#)

Maru Benches

Three Slat Bench, Indoor
Designed by Studio Gorm, 2020
Made in the USA.



Depth Width Height
17.75" 85.5" 17"

Core Product

Three Slat Bench - Beech, Indoor

Core Code

SG03-IND-S3-86W-B

Standard with Core Product

Glides
Solid Beech Wood Frame

Upholstery Configurations

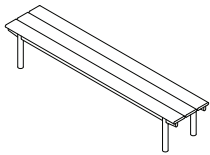

Configuration 1.3
(none)

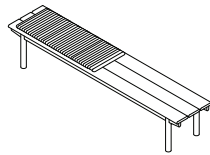

Configuration 2.3
-PC2

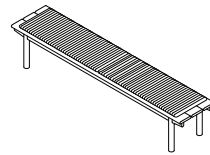

Configuration 3.3
-PC2-PG2

Textile Yardage

Pad: 1.50 (each)

Upholstery Configurations - List Price by Textile Grade

	Base	COM / 1	2	3	4	5	6	7	8	9	10	11	12	13	14	15
Configuration 1.3	2235	n/a	n/a	n/a	n/a	n/a	n/a	n/a	n/a	n/a	n/a	n/a	n/a	n/a	n/a	n/a
Configuration 2.3		2915	2935	2959	2975	2998	3016	3044	3082	3119	3166	3121	3278	3400	3494	3682
Configuration 3.3		3596	3635	3683	3716	3761	3797	3854	3929	4004	40973	4208	4322	4565	4754	5129

Options and Notes overleaf

Options

Wood Species	Code	List Price Add
Beech	B	0
Ash	A	389
Walnut	W	2890

Wood Finishes

Clear over Beech/Ash/Walnut	WCB/WCA/WCW	0
Ash with Stain Finish	WGA/WOA/WWQ/WNP	250

Accessories (see below for visuals)

Table, Round	T1	426
Table, Obround	T2	524
Power Module/s	PM1/PM2	273/795

Other Options

Veneer Table Top(s), Beech	VTB	0
Veneer Table Top(s), Ash	VTA	28
Veneer Table Top(s), Walnut	VTW	36
Forbo Linoleum Table Top(s)	FTT	127
Veneer Table Top(s), Ash with Stain	WGA/WOA/WWQ/WNP	60

Specifiable Finishes

- Linoleum Choose from Forbo linoleum products on page 7
- Textiles Choose from Maharam or Kvadrat textiles on page 74, or contact Memo for assistance with COM fabrics
- Wood/Veneer Choose from Memo Wood Finishes on page 7

Accessories (visuals)

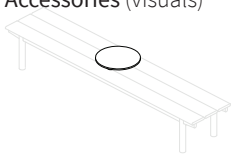

Table, Round
See below for locations

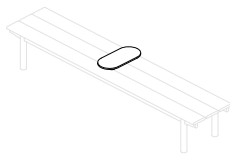

Table, Obround
See below for locations

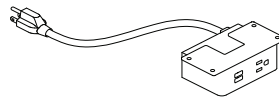

Power Module
1-Power, 2-USB

Table Locations (Round Table shown)

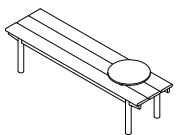

-T1F2
For Configurations 1.3-S

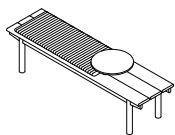

-T1E2
For Configuration 2.3-S

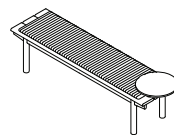

-T1G2
For Configuration 3.3-S

Notes overleaf

Notes

Pricing includes Freight within Continental US

For step-by-step specifications and quotes, access our live quote tool online at → [Quotes](#)

Maru Benches

Five Slat Bench, Indoor
Designed by Studio Gorm, 2020
Made in the USA.

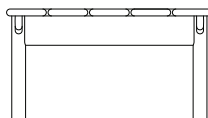

Depth	Width	Height
29.75"	85.5"	17"

Core Product

Five Slat Bench - Beech, Indoor

Core Code

SG03-IND-S5-86W-B

Standard with Core Product

Glides
Solid Beech Wood Frame

Upholstery Configurations

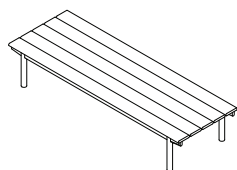

Configuration 1.5
(none)

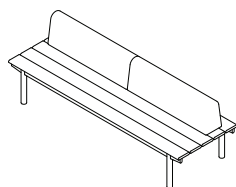

Configuration 2.5
-BC2-BG2

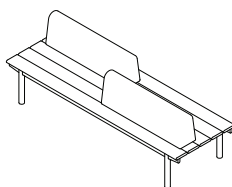

Configuration 3.5
-BC2-BG4

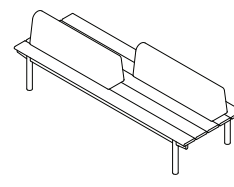

Configuration 4.5
-BC4-BG2

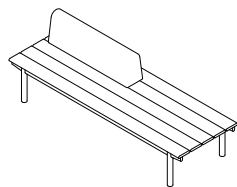

Configuration 5.5
-BC2

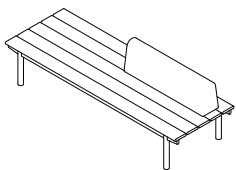

Configuration 6.5
-BG2

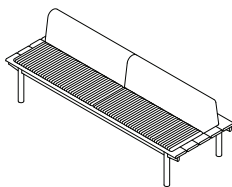

Configuration 7.5
-BC2-BG2-PC4-PG4

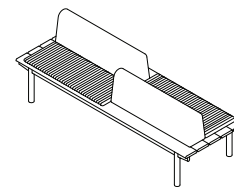

Configuration 8.5
-BC2-BG4-PC4-PG2

More Configurations, Pricing, Options, and Notes overleaf

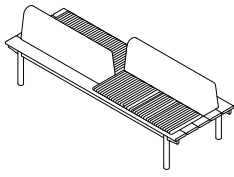

Configuration 9.5
-BG4-BG2-PC2-PG4

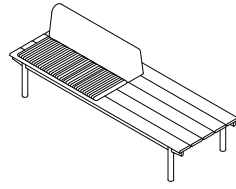

Configuration 10.5
-BC2-PC4

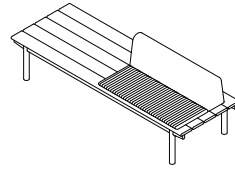

Configuration 11.5
-BG2-PG4

Textile Yardage

Bolster: 1.25 (each)
Pad: 1.50 (each)

Upholstery Configurations - List Price by Textile Grade*

	Base	COM / 1	2	3	4	5	6	7	8	9	10	11	12	13	14	15
Configuration 1.5	3321	n/a	n/a	n/a	n/a	n/a	n/a	n/a	n/a	n/a	n/a	n/a	n/a	n/a	n/a	n/a
Configuration 2.5		4659	4691	4731	4759	4797	4827	4875	4937	4999	5077	5169	5265	5467	5625	5937
Configuration 3.5		4659	4691	4731	4759	4797	4827	4875	4937	4999	5077	5169	5265	5467	5625	5937
Configuration 4.5		4659	4691	4731	4759	4797	4827	4875	4937	4999	5077	5169	5265	5467	5625	5937
Configuration 5.5		3990	4006	4026	4040	4059	4074	4098	4129	4160	4199	4245	4293	4394	4473	4629
Configuration 6.5		3990	4006	4026	4040	4059	4074	4098	4129	4160	4199	4245	4293	4394	4473	4629
Configuration 7.5		6020	6092	6180	6240	6323	6389	6439	6631	6768	6939	7142	7351	7797	8143	8831
Configuration 8.5		6020	6092	6180	6240	6323	6389	6439	6631	6768	6939	7142	7351	7797	8143	8831
Configuration 9.5		6020	6092	6180	6240	6323	6389	6439	6631	6768	6939	7142	7351	7797	8143	8831
Configuration 10.5		4671	4706	4750	4781	4822	4855	4907	4976	5045	5130	5232	5336	5559	5732	6076
Configuration 11.5		4671	4706	4750	4781	4822	4855	4907	4976	5045	5130	5232	5336	5559	5732	6076

*Pricing assumes single textile selection for pads and bolsters. For multiple textiles please visit → Quotes

Options

Wood Species	Code	List Price Add
Beech	B	0
Ash	A	820
Walnut	W	5269

Wood Finishes	Code	List Price Add
Clear over Beech/Ash/Walnut	WCB/WCA/WCW	0
Ash with Stain Finish	WGA/WOA/WWQ/WNP	310

Accessories (see below for visuals)	Code	List Price Add
-------------------------------------	------	----------------

More Options, Visuals, and Notes overleaf

Dowel Partition, Ash	SCR1A	2853
Dowel Partition, Ash with Stain Finish	WGA/WOA/WWQ/WNP	450
Table, Round	T1	426
Table, Obround	T2	524
Power Module/s	PM1/PM2	273/795

Other Options

Multiple Textiles (bolster/pad)	TA	140
Veneer Table Top(s), Beech	VTB	0 (per table)
Veneer Table Top(s), Ash	VTA	28 (per table)
Veneer Table Top(s), Walnut	VTW	36 (per table)
Veneer Table Top(s), Ash with Stain	WGA/WOA/WWQ/WNP	60 (per table)
Forbo Linoleum Table Top(s)	FTT	126 (per table)

Specifiable Finishes

Linoleum Choose from Forbo linoleum products on page 7

Accessories (visuals)

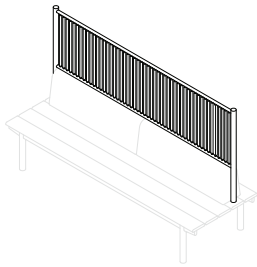

Dowel Partition
Only for Configurations 2.5, 7.5

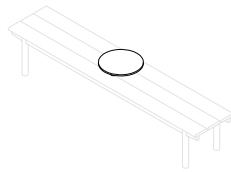

Table, Round
See below for locations

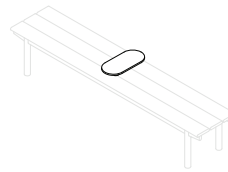

Table, Obround
See below for locations

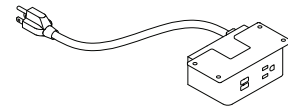

Power Module
1-Power, 2-USB

Table Locations (Round Table shown)

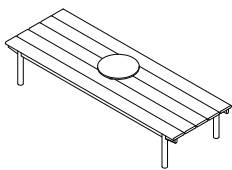

-T1E3
For Configuration 1.5

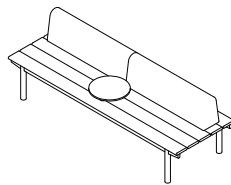

-T1E4
For Configurations 2.5, 5.5, 6.5, 7.5, 10.5, 11.5

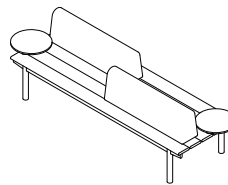

-T1A4-T1I2
For Configuration 3.5, 8.5

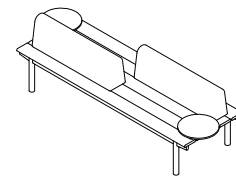

-T1A2-T1I4
For Configuration 4.5, 9.5

Textiles
Wood/Veneer

Choose from Maharam or Kvadrat textiles on page 74, or contact Memo for assistance with COM fabrics
Choose from Memo Wood Finishes on page 7

Notes

Pricing includes Freight within Continental US

Notes overleaf

For step-by-step specifications and quotes, access our live quote tool online at → [Quotes](#)

Maru Benches

Seven Slat Bench, Indoor
Designed by Studio Gorm, 2020
Made in the USA.

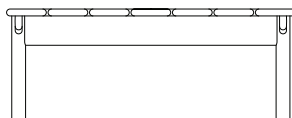

Depth	Width	Height
41.75"	85.5"	17"

Core Product

Seven Slat Bench - Beech, Indoor

Core Code

SG03-IND-S7-86W-B

Standard with Core Product

Glides
Solid Beech Wood Frame

Upholstery Configurations

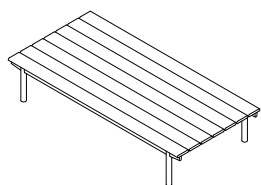

Configuration 1.7
(none)

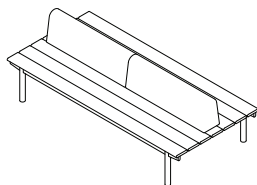

Configuration 2.7
-BC4-BG4

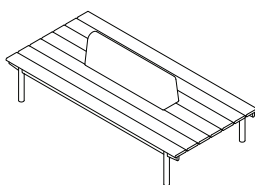

Configuration 3.7
-BE4

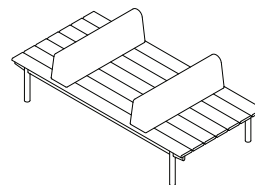

Configuration 4.7
-BC4R-BG4R

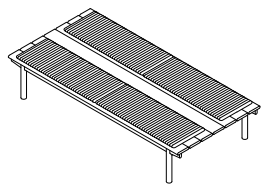

Configuration 5.7
-PC2-PC6-PG2-PG6

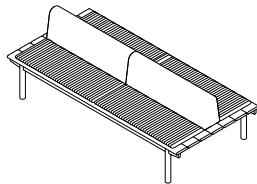

Configuration 6.7
-BC4-BG4-PC2-PC6-PG2-PG6

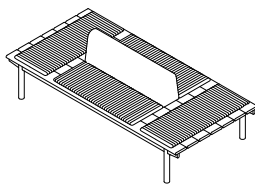

Configuration 7.7
-BE4-PB4R-PE2-PE6-PH4R

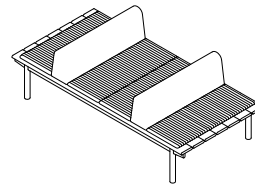

Configuration 8.7
-BC4R-BG4R-PB4R-PD4R-PF4R-PH4R

Pricing, Options, and Notes overleaf

Textile Yardage

Bolster:	1.25	(each)
Pad:	1.50	(each)

Upholstery Configurations - List Price by Textile Grade*

	Base COM /	1	2	3	4	5	6	7	8	9	10	11	12	13	14	15
Configuration 1.7	3752	n/a	n/a	n/a	n/a	n/a	n/a	n/a	n/a	n/a	n/a	n/a	n/a	n/a	n/a	n/a
Configuration 2.7	5090	5122	5162	5190	5228	5258	5306	5368	5430	5508	5600	5696	5898	6056	6368	
Configuration 3.7	4421	4437	4457	4471	4490	4505	4529	4560	4591	4630	4676	4724	4825	4904	5060	
Configuration 4.7	5090	5122	5162	5190	5228	5258	5306	5368	5430	5508	5600	5696	5898	6056	6368	
Configuration 5.7	6474	6552	6648	6714	6804	6876	6990	7140	7290	7476	7698	7926	8412	8790	9540	
Configuration 6.7	7812	7923	8059	8152	8280	8382	8543	8756	8968	9232	9546	9869	10558	11093	12156	
Configuration 7.7	7143	7238	7354	7433	7542	7629	7767	7948	8129	8354	8622	8898	9485	9942	10848	
Configuration 8.7	7812	7923	8059	8152	8280	8382	8543	8756	8968	9232	9546	9869	10558	11093	12156	

*Pricing assumes single textile selection for pads and bolsters. For multiple textiles please visit → Quotes

Options

Wood Species	Code	List Price Add
Beech	B	0
Ash	A	902
Walnut	W	5842

Wood Finishes

Clear over Beech/Ash/Walnut	WCB/WCA/WCW	0
Ash with Stain Finish	WGA/WOA/WWQ/WNP	360

Accessories (see following page for visuals)

Dowel Partition, Ash	SCR1A	2853
Dowel Partition, Ash with Stain Finish	WGA/WOA/WWQ/WNP	450
Table, Round	T1	426
Table, Obround	T2	524
Power Module/s	PM1/PM2	273/795

Other Options

	Code	List Price Add
Multiple Textiles (bolster/pad)	TA	140
Veneer Table Top(s), Beech	VTB	0
Veneer Table Top(s), Ash	VTA	28 (per table)

More Options, Visuals, and Notes overleaf

Veneer Table Top(s), Walnut	VTW	36 (per table)
Veneer Table Top(s), Ash with Stain Finish	WGA/WOA/WWQ/WNP	60 (per table)
Forbo Linoleum Table Top(s)	FTT	126 (per table)

Specifiable Finishes

- Linoleum Choose from Forbo linoleum products on page 7
- Textiles Choose from Maharam or Kvadrat textiles on page 74, or contact Memo for assistance with COM fabrics
- Wood/Veneer Choose from Memo Wood Finishes on page 7

Accessories (visuals)

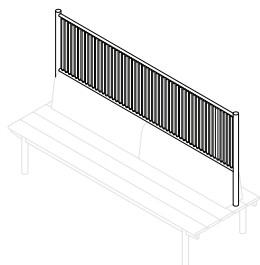

Dowel Partition
Only for Configurations 2.7, 6.7

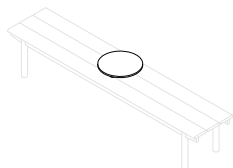

Table, Round
See below for locations

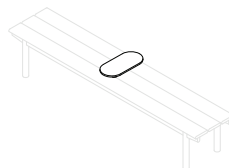

Table, Obround
See below for locations

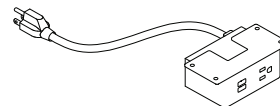

Power Module
1-Power, 2-USB

Table Locations (Round Table shown)

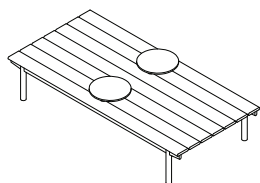

-T1E2-T1E6
For Configurations 1.7, 5.7

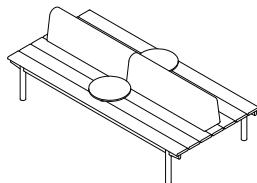

-T1E2-T1E6
For Configurations 2.7, 6.7

Notes

Pricing includes Freight within Continental US
For step-by-step specifications and quotes, access our live quote tool online at → Quotes

Penna

Lounge

Designed by Studio Gorm, 2019

Made in the USA.

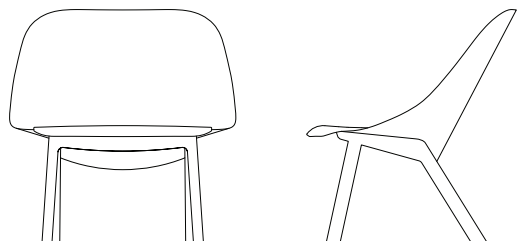

Depth	Width	Height
32"	25.5"	30"

Core Product

Lounge - Ash
Lounge - Walnut

Core Code

SG01-01-A
SG01-01-W

Textile Yardage

Total: 3.5

Seat	Back	Arms
1.0	2.5	n/a

List Price by Textile Grade*

	COM / 1	2	3	4	5	6	7	8	9	10	11	12	13	14	15
SG01-01-A	3086	3132	3188	3226	3279	3321	3387	3475	3562	3671	3800	3933	4217	4437	4875
SG01-01-W	3693	3739	3795	3833	3886	3928	3994	4082	4169	4278	4407	4540	4824	5044	5482

*Pricing assumes a single textile selection for seat and back. For multiple textiles please visit → Quotes

Standard with Core Product

Non-Marring Glides

Options and Notes overleaf

Options

Component	Code	List Price Add
Multiple Textiles (Seat/Back)	TA	140
Stain Finish on Base	WOA/WWA/WGA/WNP	90

Specifiable Finishes

- Textiles Choose from Maharam or Kvadrat textiles on page 74, or contact Memo for assistance with COM fabrics
- Wood Choose from Memo Wood Finishes on page 7

Notes

- Pricing includes Freight within Continental US
- Multiple Textile option allows for separate seat and back textiles
- For step-by-step specifications and quotes, access our live quote tool online at → [Quotes](#)

Penna

Large Round Table

Designed by Studio Gorm, 2019

Made in the USA.

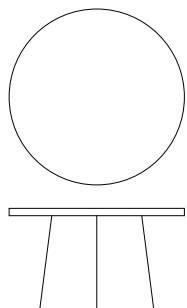

Depth	Width	Height
30"	30"	17.5"

Core Product	Core Code	List Price
Large Round Table - Ash	SG01-T1-A	2345
Large Round Table - Walnut	SG01-T1-W	2686

Standard with Core Product

- Glides
- Forbo Linoleum Top
- Solid Wood Edge Band (finish to match base)
- Wood Veneer Base

Options

Component	Code	List Price Add
Forbo Linoleum Top	FTT	0
Wood Veneer Top (Ash)	VTA	141
Wood Veneer Top (Walnut)	VTW	266
Ash with Stain Finish	WOA/WWA/WGA/WNP	113
Power Module (2-power, 2-USB)	PM1	343

Specifiable Finishes

- Linoleum Choose from Forbo linoleum products on page 7
- Wood Choose from Memo Wood Finishes on page 7

Notes

Pricing includes freight within Continental US
For step-by-step specifications and quotes, access our live quote tool online at → Quotes

Penna

Obround Table

Designed by Studio Gorm, 2019

Made in the USA.

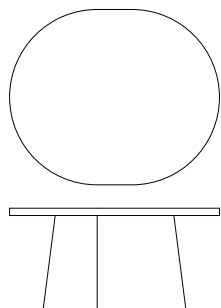

Depth	Width	Height
30"	36"	17.5"

Core Product	Core Code	List Price
Obround Table - Ash	SG01-T2-A	2648
Obround Table - Walnut	SG01-T2-W	2894

Standard with Core Product

- Glides
- Forbo Linoleum Top
- Solid Wood Edge Band (finish to match base)
- Wood Veneer Base

Options

Component	Code	List Price Add
Forbo Linoleum Top	FTT	0
Wood Veneer Top (Ash)	VTA	168
Wood Veneer Top (Walnut)	VTW	281
Ash with Stain Finish	WOA/WWA/WGA/WNP	129
Power Module (2-power, 2-USB)	PM1	343

Specifiable Finishes

- Linoleum Choose from Forbo linoleum products on page 7
- Wood Choose from Memo Wood Finishes on page 7

Notes

Pricing includes Freight within Continental US
For step-by-step specifications and quotes, access our live quote tool online at → Quotes

Penna

Small Round Table

Designed by Studio Gorm, 2019

Made in the USA.

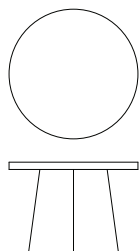

Depth	Width	Height
22.5"	22.5"	16"

Core Product	Core Code	List Price
Small Round Table - Ash	SG01-T3-A	2142
Small Round Table - Walnut	SG01-T3-W	2353

Standard with Core Product

- Glides
- Forbo Linoleum Top
- Solid Wood Edge Band (finish to match base)
- Wood Veneer Base

Options

Component	Code	List Price Add
Forbo Linoleum Top	FTT	0
Wood Veneer Top (Ash)	VTA	64
Wood Veneer Top (Walnut)	VTW	102
Ash with Stain Finish	WOA/WWA/WGA/WNP	110
Power Module (2-power, 2-USB)	PM1	343

Specifiable Finishes

- Linoleum Choose from Forbo linoleum products on page 7
- Wood Choose from Memo Wood Finishes on page 7

Notes

Pricing includes Freight within Continental US
For step-by-step specifications and quotes, access our live quote tool online at → Quotes

Penna

Bar Table

Designed by Studio Gorm, 2020

Made in the USA.

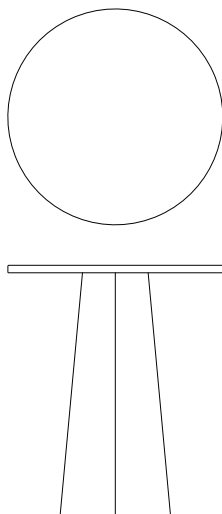

Depth	Width	Height
36"	36"	42"

Core Product	Core Code	List Price
Bar Table - Ash	SG01-T8-36D-A	4421
Bar Table - Walnut	SG01-T8-36D-W	4715

Standard with Core Product

- Glides
- Forbo Linoleum Top
- Solid Wood Edge Band (finish to match base)
- Wood Veneer Base

Options

Component	Code	List Price Add
Forbo Linoleum Top	FTT	0
Wood Veneer Top (Ash)	VTA	262
Wood Veneer Top (Walnut)	VTW	350
Ash with Stain Finish	WOA/WWA/WGA/WNP	147
Power Module (2-power, 2-USB)	PM1	343

Specifiable Finishes

- Linoleum Choose from Forbo linoleum products on page 7
- Wood Choose from Memo Wood Finishes on page 7

Notes

Bases ship with sandbags in certain models, for ballast

Pricing includes freight within Continental US

For step-by-step specifications and quotes, access our live quote tool online at → [Quotes](#)

Penna

Café Table

Designed by Studio Gorm, 2020

Made in the USA.

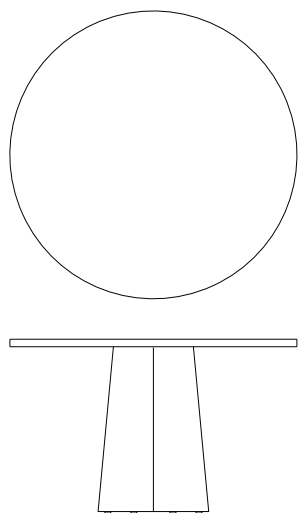

Depth	Width	Height
48"	48"	29"

Core Product	Core Code	List Price
Café Table - Ash	SG01-T6-48D-A	4480
Café Table - Walnut	SG01-T6-48D-W	4775

Standard with Core Product

- Glides
- Forbo Linoleum Top
- Solid Wood Edge Band (finish to match base)
- Wood Veneer Base

Options

Component	Code	List Price Add
Forbo Linoleum Top	FTT	0
Wood Veneer Top (Ash)	VTA	267
Wood Veneer Top (Walnut)	VTW	350
Ash with Stain Finish	WOA/WWA/WGA/WNP	156
Power Module (2-power, 2-USB)	PM1	343

Specifiable Finishes

- Linoleum Choose from Forbo linoleum products on page 7
- Wood Choose from Memo Wood Finishes on page 7

Notes

Bases ship with sandbags in certain models, for ballast

Pricing includes freight within Continental US

For step-by-step specifications and quotes, access our live quote tool online at → [Quotes](#)

Penna

Meeting Table

Designed by Studio Gorm, 2020

Made in the USA.

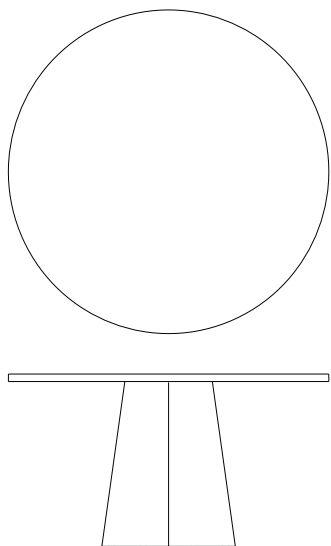

Depth	Width	Height
54"	54"	29"

Core Product	Core Code	List Price
Meeting Table - Ash	SG01-T7-54D-A	4653
Meeting Table - Walnut	SG01-T7-54D-W	4968

Standard with Core Product

- Glides
- Forbo Linoleum Top
- Solid Wood Edge Band (finish to match base)
- Wood Veneer Base

Options

Component	Code	List Price Add
Forbo Linoleum Top	FTT	0
Wood Veneer Top (Ash)	VTA	296
Wood Veneer Top (Walnut)	VTW	385
Ash with Stain Finish	WOA/WWA/WGA/WNP	165
Power Module (2-power, 2-USB)	PM1	343

Specifiable Finishes

- Linoleum Choose from Forbo linoleum products on page 7
- Wood Choose from Memo Wood Finishes on page 7

Notes

Bases ship with sandbags in certain models, for ballast

Pricing includes freight within Continental US

For step-by-step specifications and quotes, access our live quote tool online at → [Quotes](#)

Prose Seating

Side Chair with Arms

Designed by Memo Studio, 2017

Made in the USA.

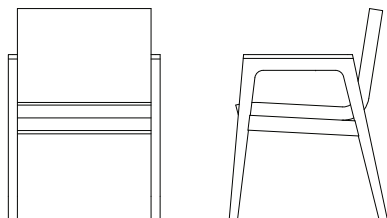

Depth	Width	Height
24"	23"	33"

Core Product

- Side Chair with Arms - Ash
- Side Chair with Arms - Beech
- Side Chair with Arms - Walnut

Core Code

- GC01-10-A
- GC01-10-B
- GC01-10-W

Textile Yardage	Seat	Back	Arms
Total: 1.50	n/a	n/a	n/a

List Price by Textile Grade

	COM / 1	2	3	4	5	6	7	8	9	10	11	12	13	14	15
GC01-10-A	1685	1705	1729	1745	1768	1786	1814	1852	1889	1936	1991	2048	2170	2264	2452
GC01-10-B	1518	1537	1561	1578	1600	1618	1647	1684	1722	1768	1824	1881	2002	2097	2284
GC01-10-W	2863	2882	2906	2923	2945	2963	2992	3029	3067	3113	3169	3226	3347	3442	3629

Standard with Core Product

- Glides
- High Resilience Polyurethane Foam
- Solid Wood Arm Caps

Options and Notes overleaf

Options

Component	Code	List Price Add						
Ash with Stain Finish	WOA/WWA/WGA/WNP	90						
Solid Surface Arm Caps	by Grade (right)	CA1	CA2	CA3	CA4	CA5	CA6	CA7
		277	337	337	474	474	553	553
Removable Covers	RC	149						
Moisture Barrier	MB	222						

Specifiable Finishes

- Solid Surface Choose from Corian solid surface products on page 88
- Textiles Choose from Maharam or Kvadrat textiles on page 74, or contact Memo for assistance with COM fabrics
- Wood Choose from Memo Wood Finishes on page 7

Notes

Pricing includes Freight within Continental US
 Due to its continuous seat and back, multiple fabric configurations are not supported on the Prose Side Chair with Arms
 For step-by-step specifications and quotes, access our live quote tool online at memofurniture.com/quotes

Prose Seating

Plus Chair

Designed by Memo Studio, 2017

Made in the USA.

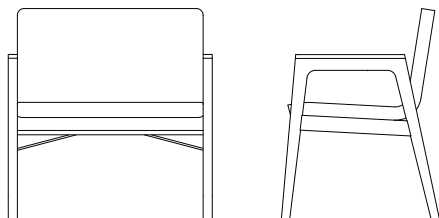

Depth	Width	Height
24"	30.75"	33"

Core Product

Core Code

Plus Chair - Ash	GC01-15-A
Plus Chair - Beech	GC01-15-B
Plus Chair - Walnut	GC01-15-W

Textile Yardage	Seat	Back	Arms
Total: 2.00	n/a	n/a	n/a

List Price by Textile Grade

	COM / 1	2	3	4	5	6	7	8	9	10	11	12	13	14	15
GC01-15-A	2129	2155	2187	2209	2239	2263	2301	2351	2401	2463	2537	2613	2775	2901	3151
GC01-15-B	1925	1951	1993	2005	2035	2059	2097	2147	2197	2259	2333	2409	2571	2697	2947
GC01-15-W	3238	3264	3296	3318	3348	3372	3410	3460	3510	3572	3646	3722	3884	4010	4260

Standard with Core Product

Glides

High Resilience Poyeurethane Foam

Options and Notes overleaf

Options

Component	Code	List Price Add							
Ash with Stain Finish	WOA/WWA/WGA/WNP	105							
Solid Surface Arm Caps	by Grade (right)	CA1 277	CA2 337	CA3 337	CA4 474	CA5 474	CA6 553	CA7 553	
Removable Covers	RC	179							
Moisture Barrier	MB	222							

Specifiable Finishes

- Solid Surface Choose from Corian solid surface products on page 88
- Textiles Choose from Maharam or Kvadrat textiles on page 74, or contact Memo for assistance with COM fabrics
- Wood Choose from Memo Wood Finishes on page 7

Notes

Pricing includes Freight within Continental US
 Due to its continuous seat and back, multiple fabric configurations are not supported on the Prose Plus Chair
 For step-by-step specifications and quotes, access our live quote tool online at memofurniture.com/quotes

Prose Seating

Settee

Designed by Memo Studio, 2017

Made in the USA.

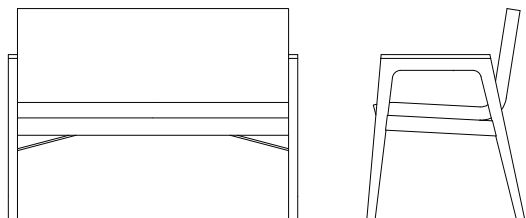

Depth	Width	Height
24"	43.75"	33"

Core Product

- Settee - Ash
- Settee - Beech
- Settee - Walnut

Core Code

- GC01-22-A
- GC01-22-B
- GC01-22-W

Textile Yardage	Seat	Back	Arms
Total: 2.50	n/a	n/a	n/a

List Price by Textile Grade

	COM / 1	2	3	4	5	6	7	8	9	10	11	12	13	14	15
GC01-22-A	2790	2822	2862	2890	2927	2957	3005	3067	3130	3207	3300	3395	3597	2755	4067
GC01-22-B	2556	2588	2628	2656	2693	2723	2771	2833	2896	2973	3066	3161	3361	3521	3833
GC01-22-W	3725	3757	3797	3825	3862	3892	3940	4002	4065	4142	4235	4330	4532	4690	5002

Standard with Core Product

- Glides
- High Resilience Polyurethane Foam

Options and Notes overleaf

Options

Component	Code	List Price Add							
Ash with Stain Finish	WOA/WWA/WGA/WNP	120							
Solid Surface Arm Caps	by Grade (right)	CA1 277	CA2 337	CA3 337	CA4 474	CA5 474	CA6 553	CA7 553	
Removable Covers	RC	197							
Moisture Barrier	MB	244							

Specifiable Finishes

- Solid Surface Choose from Corian solid surface products on page 88
- Textiles Choose from Maharam or Kvadrat textiles on page 74, or contact Memo for assistance with COM fabrics
- Wood Choose from Memo Wood Finishes on page 7

Notes

Pricing includes Freight within Continental US
 Due to its continuous seat and back, multiple fabric configurations are not supported on the Prose Settee
 For step-by-step specifications and quotes, access our live quote tool online at memofurniture.com/quotes

Prose Seating

Pull-Up Chair

Designed by Memo Studio, 2017

Made in the USA.

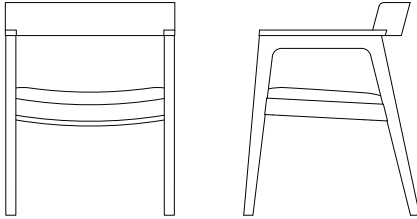

Depth	Width	Height
24"	23"	29.5"

Core Product

- Pull-Up Chair - Ash
- Pull-Up Chair - Beech
- Pull-Up Chair - Walnut

Core Code

- GC01-11-A
- GC01-11-B
- GC01-11-W

Textile Yardage	Seat	Back	Arms
Total: 1.00	n/a	n/a	n/a

List Price by Textile Grade

	COM / 1	2	3	4	5	6	7	8	9	10	11	12	13	14	15
GC01-11-A	1825	1838	1854	1865	1880	1892	1911	1936	1961	1992	2029	2067	2148	2211	2336
GC01-11-B	1655	1668	1684	1695	1710	1722	1741	1766	1791	1822	1859	1897	1978	2041	2166
GC01-11-W	3238	3251	3267	3278	3293	3305	3324	3349	3374	3405	3442	3480	3561	3624	3749

Standard with Core Product

- Glides
- High Resilience Polyurethane Foam

Options

Component	Code	List Price Add
Ash with Stain Finish	WOA/WWA/WGA/WNP	90
Removable Covers	RC	119
Moisture Barrier	MB	122

Specifiable Finishes

- Textiles Choose from Maharam or Kvadrat textiles on page 74, or contact Memo for assistance with COM fabrics
- Wood Choose from Memo Wood Finishes on page 7

Notes

Pricing includes Freight within Continental US
For step-by-step specifications and quotes, access our live quote tool online at memofurniture.com/quotes

Prose Seating

Lounge

Designed by Memo Studio, 2017

Made in the USA.

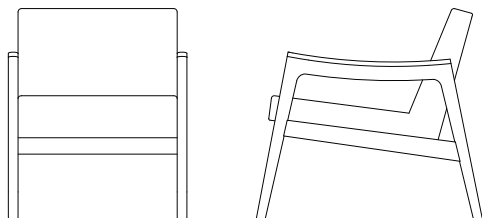

Depth	Width	Height
32"	25.5"	30"

Core Product

- Lounge - Ash
- Lounge - Beech
- Lounge - Walnut

Core Code

- GC01-01-A
- GC01-01-B
- GC01-01-W

Textile Yardage	Seat	Back	Arms
Total: 2.00	1.00	1.00	n/a

List Price by Textile Grade

	COM / 1	2	3	4	5	6	7	8	9	10	11	12	13	14	15
GC01-01-A	2488	2514	2546	2568	2598	2622	2660	2710	2760	2822	2896	2972	3134	3260	3510
GC01-01-B	2260	2286	2318	2340	2370	2394	2432	2482	2532	2594	2668	2744	2906	3032	3282
GC01-01-W	3700	3726	3758	3780	3810	3834	3872	3922	3972	4034	4108	4184	4346	4472	4722

Standard with Core Product

Glides

High Resilience Polyurethane Foam

Options and Notes overleaf

Options

Component	Code	List Price Add						
Ash with Stained Finish	WOA/WWA/WGA/WNP	120						
Solid Surface Arm Caps	by Grade (right)	CA1	CA2	CA3	CA4	CA5	CA6	CA7
		291	354	354	499	499	582	582
Removable Covers	RC	179						
Moisture Barrier	MB	222						
Multiple Textiles (Seat/Back)	TA	140						

Specifiable Finishes

- Solid Surface Choose from Corian solid surface products on page 88
- Textiles Choose from Maharam or Kvadrat textiles on page 74, or contact Memo for assistance with COM fabrics
- Wood Choose from Memo Wood Finishes on page 7

Notes

- Pricing includes Freight within Continental US
- Available in custom widths per engineering and quote approval
- Multiple fabric option allows for separate seat and back textiles
- For step-by-step specifications and quotes, access our live quote tool online at memofurniture.com/quotes

Prose Seating

Loveseat

Designed by Memo Studio, 2017

Made in the USA.

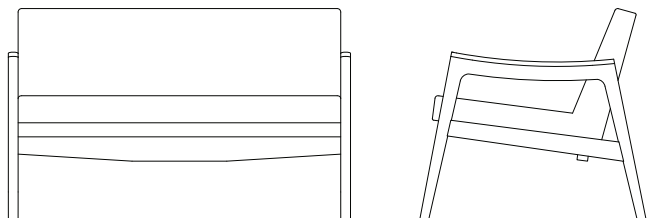

Depth	Width	Height
32"	48"	30"

Core Product

- Loveseat - Ash
- Loveseat - Beech
- Loveseat - Walnut

Core Code

- GC01-02-A
- GC01-02-B
- GC01-02-W

Textile Yardage	Seat	Back	Arms
Total: 4.00	2.00	2.00	n/a

List Price by Textile Grade

	COM / 1	2	3	4	5	6	7	8	9	10	11	12	13	14	15
GC01-02-A	3645	3697	3761	3805	3865	3913	3989	4089	4189	4313	4461	4613	4937	5189	5689
GC01-02-B	3313	3365	3429	3473	3533	3581	3657	3757	3857	3981	4129	4281	4605	4857	5357
GC01-02-W	5316	5368	5432	5476	5536	5584	5660	5760	5860	5984	6132	6284	6608	6860	7360

Standard with Core Product

- Glides
- High Resilience Poyeurethane Foam

Options and Notes overleaf

Options

Component	Code	List Price	Add						
Ash with Stain Finish	WOA/WWA/WGA/WNP		135						
Solid Surface Arm Caps	by Grade (right)	CA1	291	CA2	354	CA3	354	CA4	499
				CA5	499	CA6	582	CA7	582
Removable Covers	RC		219						
Moisture Barrier	MB		252						
Multiple Textiles (Seat/Back)	TA		140						

Specifiable Finishes

- Solid Surface Choose from Corian solid surface products on page 88
- Textiles Choose from Maharam or Kvadrat textiles on page 74, or contact Memo for assistance with COM fabrics
- Wood Choose from Memo Wood Finishes on page 7

Notes

- Pricing includes Freight within Continental US
- Available in custom widths per engineering and quote approval
- Multiple fabric option allows for separate seat and back textiles
- For step-by-step specifications and quotes, access our live quote tool online at memofurniture.com/quotes

Prose Tables

Free-Standing End Table
Designed by Memo Studio, 2017
Made in the USA.

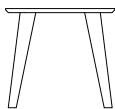

Depth	Width	Height
20"	20"	18.5"

Core Product	Core Code	List Price
Free-Standing End Table - Ash	GC01-T1-A	1256
Free-Standing End Table - Beech	GC01-T1-B	1082
Free-Standing End Table - Walnut	GC01-T1-W	1609

Standard with Core Product

Glides
Forbo Linoleum Top

Options

Component	Code	List Price Add	CT2	CT3	CT4	CT5	CT6	CT7	
Solid Surface Table Top	by Grade (right)	CT1	368	455	455	638	638	747	747
Solid Wood Table Top - Ash	WTA	188							
Solid Wood Table Top - Walnut	WTW	319							
Ash with Stain Finish	WOA/WWA/WGA/WNP	60							

Specifiable Finishes

Linoleum Choose from Forbo linoleum products on page 7
Solid Surface Choose from Corian solid surface products on page 88
Wood Choose from Memo Wood Finishes on page 7

Notes

Pricing includes Freight within Continental US
For step-by-step specifications and quotes, access our live quote tool online at memofurniture.com/quotes

Prose Tables

Free-Standing Coffee Table
Designed by Memo Studio, 2017
Made in the USA.

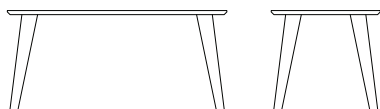

Depth	Width	Height
20"	40"	18.5"

Core Product	Core Code	List Price
Free-Standing Coffee Table - Ash	GC01-T2-A	1823
Free-Standing Coffee Table - Beech	GC01-T2-B	1570
Free-Standing Coffee Table - Walnut	GC01-T2-W	2121

Standard with Core Product

Glides
Forbo Linoleum Top

Options

Component	Code	List Price Add
Solid Surface Table Top	by Grade (right)	CT1
		CT2
Solid Wood Table Top - Ash	WTA	CT3
		CT4
Solid Wood Table Top - Walnut	WTW	CT5
		CT6
Ash with Stain Finish	WOA/WWA/WGA/WNP	CT7
		CT7

Specifiable Finishes

Linoleum Choose from Forbo linoleum products on page 7
Solid Surface Choose from Corian solid surface products on page 88
Wood Choose from Memo Wood Finishes on page 7

Notes

Pricing includes Freight within Continental US
For step-by-step specifications and quotes, access our live quote tool online at memofurniture.com/quotes

Rolo

Lounge

Designed by Studio Tolvanen, 2021

Made in the USA.

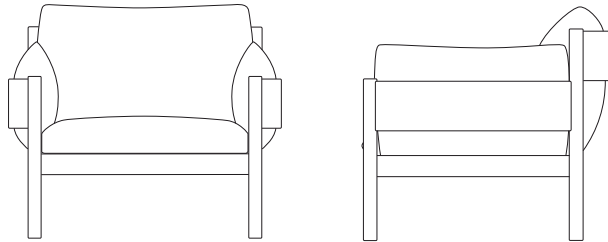

Depth Width Height
32" 36" 31"

Core Product

Lounge - Ash
Lounge - Walnut

Core Code

ST01-01-A
ST01-01-W

Textile Yardage

Total: 5.25

List Price by Textile Grade*

	COM / 1	2	3	4	5	6	7	8	9	10	11	12	13	14	15
ST01-01-A	3946	4014	4098	4156	4235	4298	4397	4529	4660	4823	5017	5216	5642	5972	6629
ST01-01-W	4469	4537	4621	4679	4757	4820	4920	5051	5183	5345	5540	5739	6164	6459	7151

*Pricing assumes non-railroaded textiles. For railroaded pricing please contact us at info@memofurniture.com

Standard with Core Product

Non-Marring Glides
High Resilience Polyurethane Foam

Options and Notes overleaf

Options

	Code	List Price Add
Clear Finish (by species)	WCA/WCW	0
Ash with Stain Finish	WOA/WWA/WGA/WNP	126

Specifiable Finishes

- Textiles Choose from Maharam or Kvadrat textiles on page 74, or contact Memo for assistance with COM fabrics
- Wood Choose from Memo Wood Finishes on page 7

Notes

Pricing includes Freight within Continental US
For step-by-step specifications and quotes, access our live quote tool online at → [Quotes](#)

Rolo

Loveseat

Designed by Studio Tolvanen, 2021

Made in the USA.

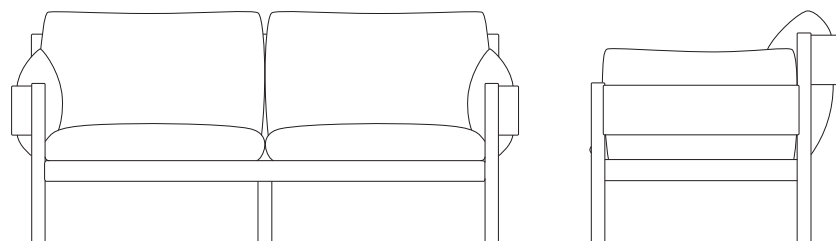

Depth Width Height
32" 65" 31"

Core Product

Loveseat - Ash
Loveseat - Walnut

Core Code

ST01-02-A
ST01-02-W

Textile Yardage

Total: 8.25

List Price by Textile Grade*

	COM / 1	2	3	4	5	6	7	8	9	10	11	12	13	14	15
ST01-02-A	5877	5985	6117	6207	6331	6430	6587	6793	6999	7255	7560	7874	8542	9062	10093
ST01-02-W	6832	6939	7071	7162	7285	7384	7541	7747	7954	8209	8515	8828	9496	10016	11047

*Pricing assumes non-railroaded textiles. For railroaded pricing please contact us at info@memofurniture.com

Standard with Core Product

Non-Marring Glides
High Resilience Polyurethane Foam

Options and Notes overleaf

Options

	Code	List Price Add
Clear Finish (by species)	WCA/WCW	0
Ash with Stain Finish	WOA/WWA/WGA/WNP	252

Specifiable Finishes

- Textiles Choose from Maharam or Kvadrat textiles on page 74, or contact Memo for assistance with COM fabrics
- Wood Choose from Memo Wood Finishes on page 7

Notes

Pricing includes Freight within Continental US
For step-by-step specifications and quotes, access our live quote tool online at → [Quotes](#)

Rolo

Sofa

Designed by Studio Tolvanen, 2021

Made in the USA.

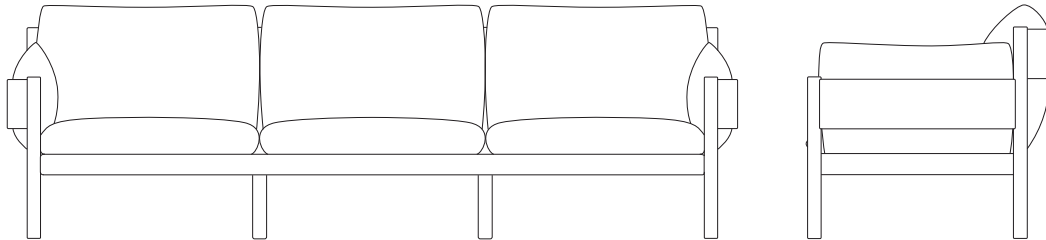

Depth Width Height
32" 94" 31"

Core Product

Sofa - Ash
Sofa - Walnut

Core Code

ST01-03-A
ST01-03-W

Textile Yardage

Total: 11.5

List Price by Textile Grade*

	COM / 1	2	3	4	5	6	7	8	9	10	11	12	13	14	15
ST01-03-A	8029	8179	8363	8489	8662	8800	9018	9306	9593	9950	10375	10812	11744	12468	13906
ST01-03-W	9539	9688	9872	9999	10171	10309	10528	10815	11103	11459	11885	12322	13253	13978	15415

*Pricing assumes non-railroaded textiles. For railroaded pricing please contact us at info@memofurniture.com

Standard with Core Product

Non-Marring Glides
High Resilience Polyurethane Foam

Options and Notes overleaf

Options

	Code	List Price Add
Clear Finish (by species)	WCA/WCW	0
Ash with Stain Finish	WOA/WWA/WGA/WNP	378

Specifiable Finishes

- Textiles Choose from Maharam or Kvadrat textiles on page 74, or contact Memo for assistance with COM fabrics
- Wood Choose from Memo Wood Finishes on page 7

Notes

Pricing includes Freight within Continental US
For step-by-step specifications and quotes, access our live quote tool online at → [Quotes](#)

Rolo

Side Table

Designed by Studio Tolvanen, 2021

Made in the USA.

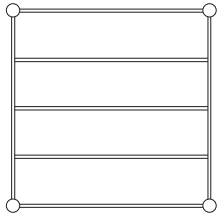

Depth	Width	Height
27.75"	27.75"	11"

Core Product	Core Code	List Price
Side Table - Ash	ST01-T1-A	1233
Side Table - Walnut	ST01-T1-W	1983

Standard with Core Product

Glides

Options

Specifiable Finishes

Choose from Memo Wood Finishes on page 7

	Code	List Price Add
Clear Finish (by species)	WCA/WCW	0
Ash with Stain Finish	WOA/WWA/WGA/WNP	126

Notes

Pricing includes freight within Continental US

For step-by-step specifications and quotes, access our live quote tool online at → [Quotes](#)

Rolo

Coffee Table

Designed by Studio Tolvanen, 2021

Made in the USA.

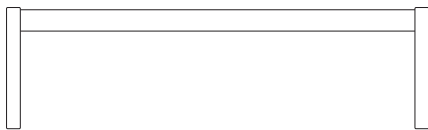
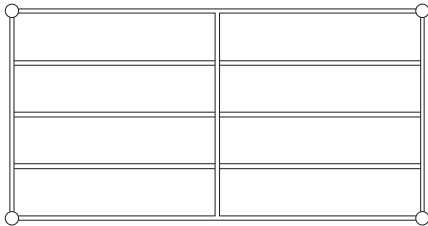

Depth	Width	Height
27.75"	53.75"	15"

Core Product	Core Code	List Price
Coffee Table - Ash	ST01-T2-A	1539
Coffee Table - Walnut	ST01-T2-W	2792

Standard with Core Product

Glides

Options

Specifiable Finishes

Choose from Memo Wood Finishes on page 7

	Code	List Price Add
Clear Finish (by species)	WCA/WCW	0
Ash with Stain Finish	WOA/WWA/WGA/WNP	147

Notes

Pricing includes freight within Continental US

For step-by-step specifications and quotes, access our live quote tool online at → [Quotes](#)

Textiles Graded-in sorted by pattern name: **Kvadrat**

Pattern Name	Group	Pattern Name	Group
Apparel by Febrik	13	Parkland	9
Ara	10	Patio	8
Atlas	9	Phlox (RAF)	10
Atom (RAF)	14	Pilot (RAF)	14
Atrium Outdoor	10	Planum by Febrik	12
Balder 3 (RAF)	12	Plecto by Febrik	12
Basel	8	Pro 3	9
Broken Twill Weave	9	Raas	9
Byram (RAF)	14	Razzle Dazzle by Febrik	13
Canvas 2	8	Recheck	9
Clara	8	Reflect	8
Coda	12	Reflex (RAF)	14
Colline 2	10	Revive 1	9
Crystal Field	14	Re-Wool	8
Divina 3	9	Remix	8
Divina MD	9	Ria (RAF)	15
Divina Melange	9	Rime	10
Drop by Febrik	13	San	9
Encircle	9	Savanna	9
Field 2	9	Silas (RAF)	15
Fiord 2	10	Sonar 3 (RAF)	14
Floyd	9	Sprinkles by Febrik	13
Foss	10	Steelcut 2	9
Fuse (RAF)	14	Steelcut Trio	9
Galaxy	9	Still	9
Gentle 2.1 by Febrik	14	Sunniva 2 (RAF)	10
Glow	9	Tambourine Hallingdal	14
Haku	7	Technicolor Fleck	11
Hallingdal	10	Tonica 2	8
Harald 3 (RAF)	10	Tonus	9
Hero	8	Triangle by Febrik	13
Highfield 3	10	Twill Weave	9
Husk by Febrik	13	Uniform by Febrik	12
Jaali	9	Vidar 3 (RAF)	13
Lila	11	Waterborn	13
Letters	14		
Maple	9		
Melange Nap	9		
Memory	9		
Mizmaze	11		
Molly 2	8		
Mosiac by Febrik	13		

Textiles Graded-in sorted by pattern name: **Maharam**

Pattern Name	Pattern No.	Group	Pattern Name	Pattern No.	Group
A Band Apart	466000	15	Chalet	466324	10
Abacus	466118	9	Chasm	466404	9
Abacus Standard	466140	6	Chassis	466458	9
Across	465964	9	Checker	459830	14
Agency	466001	15	Checker Split	460290	14
Akimbo	464770	9	Chime	465350	8
Albemarle	466435	13	Circles	466475	14
Alpaca Epingle	465902	15	Circles	458310	14
Alpaca Velvet	465901	15	Circuit	466089	9
Amulet	466482	12	Clamber	466385	9
Ample	466532	11	Coach Cloth	458950	14
Anagram	466067	11	Coast	466439	8
Angles	466477	15	Coin	466233	7
Apt	466392	11	Column	466192	9
Arabesque	466204	14	Compartment	466154	15
Arcade	466447	11	Compound	466196	9
Aria	459950	14	Conduit	466428	7
Article	458600	3	Confetti	466203	13
Bander	466442	14	Fore	466464	12
Bavaria Stripe	466161	15	Cosset	466524	9
Beacon	466405	10	Cotton Velvet	466199	14
Beck	466570	9	Cove	466526	13
Beryl	466508	9	Crew	466149	10
Bespoke Stripe	463540	15	Croft	466498	15
Big Stripe	466174	15	Crosspatch	458920	14
Bind	466437	12	Crush	464780	9
Blended Stripe	466412	15	Cursive	466335	10
Bluff	466489	8	Cycle	466275	8
Blumen	462870	15	Darning Sampler	466460	12
Boundary	466193	8	Darning Sampler Large	466461	12
Bright Angle	466331	11	Darning Sampler Plaid	466462	13
Bright Cube	466329	11	Deconstructed Rose	466086	15
Bright Grid	466330	11	Design 9297	465230	15
Brim	466350	10	Dingbats	465994	13
Brindle	466418	6	Dot Pattern	458300	14
Brio	466386	9	Dots	466411	13
Buffer	466492	8	Double Triangles	459840	14
Bureau	466472	6	Drape	466145	10
Bushel	466490	9	Dwell	466419	5
Campana	466571	10	Eden	466258	15
Candor	466496	8	Edges	466476	13
Caper	466384	7	Ellipsis	466334	9

Textiles Graded-in sorted by pattern name: **Maharam**

Pattern Name	Pattern No.	Group	Pattern Name	Pattern No.	Group
Elm	466557	6	Houndstooth	466253	13
Embed	466457	9	Huddle	466420	15
Emboss	466281	9	Idle	466466	14
Emit	466378	7	Imbue	466375	12
Enmesh	466338	8	Industry	466255	15
Entwine	466397	11	Inlay	466353	13
Epingle Stripe	466007	15	Insignia	466308	10
Equate	466383	9	Instill	466351	8
Etch	466502	13	Jacobs Coat	462270	14
Exaggerated Plaid	466039	14	Jasper	466563	9
Exchange	466027	6	Keen	466433	8
Facets	459850	14	Lariat	440401	3
Fathom	466013	7	Layers Garden	465916	15
Feature	466343	9	Layers Park	465918	15
Festoon	466525	9	Layers Vineyard Large	465921	15
Firma	466582	10	Layers Vineyard Small	465920	15
Flint	466543	10	Lean	466438	8
Fluent Crypton	466073	9	Ledger	463770	8
Flurry	466480	13	Lens	466323	8
Fluted Silk	465982	14	Letters	462560	13
Flutter	466430	15	Levity	466518	8
Fold	466292	10	Lift	466302	11
Foliage	466257	15	Limn	466407	11
Fore	466464	13	Linden	466537	9
Frequency	466504	8	Lineage	466127	7
Fruit	466262	13	Linen Basket	466541	15
Gallant	466485	8	Link	466328	10
Garden	466134	12	Lithe	466394	9
Gemma	466568	10	Loop	466469	8
Gemma Multi	466569	10	Luce	466566	9
Geometri	459970	14	Lunar	466356	6
Gild	466432	7	Manner	466177	2
Glaze	466506	14	Mantle	466517	6
Glen	466534	6	Massive Paisley	465915	15
Glid	466432	8	Mechanism	465952	11
Glow	466500	7	Medium	463490	3
Grid	466210	15	Mela	466483	14
Grove	466344	9	Melange Tweed	461190	14
Gust	466519	8	Meld	466387	2
Hearth	466536	12	Merit	466444	3
Herringbone Stripe	465945	15	Mesh	466371	12
Hewn	466398	11	Messenger	458640	2

Textiles Graded-in sorted by pattern name: **Maharam**

Pattern Name	Pattern No.	Group	Pattern Name	Pattern No.	Group
Metric	466014	2	Pick Crypton	466235	9
Metaphor	466553	4	Pinnacle	466503	9
Mexidot	466575	11	Pitch	466186	8
Micro	466099	7	Plait	466052	8
Mikado	459330	14	Plume	466382	14
Milestone	403901	5	Pocket	466243	9
Millerstripe	462250	14	Point	466090	14
Mimic	466136	11	Pressed Linen	466380	15
Mingled Plaid	466364	15	Pressed Plaid	466181	15
Minicheck	466268	14	Prime	466436	9
Mister	466178	10	Prompt	466493	8
Mode	466337	3	Province	466549	9
Mohair Supreme	451801	15	Quatrefoil	459340	14
Monk's Wool	457301	15	Quay	466390	8
Monsoon	466481	12	Quell	466366	14
Motley	466360	8	Queue	466443	8
Multiply	466341	7	Rail	466535	9
Murmur	466446	4	Range	466583	12
Muse	466487	2	Reef	466332	12
Names	462510	14	Regatta	466189	10
Nestle	466388	14	Relay	466453	12
Nico	466564	7	Repeat Classic Stripe	462170	14
Nimble	466488	9	Repeat Dot Ring	462150	14
Offset	465951	11	Rill	466370	8
Optik	459960	14	Roam	466520	15
Orakelblume	463900	15	Roman	466565	12
Orbit	466415	7	Roster	466445	6
Ottoman Stripe	466142	15	Route	466544	8
Overlapping Stripe	466495	14	Rule	466190	10
Painted Stripe	465998	14	Runner	466108	9
Paisley Brocade	466559	15	Runner Standard	466167	7
Palio	466107	13	Scape	466357	10
Pallet	466531	6	Scuba	464930	8
Parched Silk	465974	14	Scute	466396	8
Pare	466359	9	Scuttle	466429	8
Passel	466470	15	Segmented Stripe	466373	13
Pebble Wool	457401	15	Sendal	466550	9
Pebble Wool Multi	461200	15	Sequence	466179	9
Pepitas	466576	12	Sequential Stripe	466377	15
Pepper	466486	8	Serried	466408	10
Petra	466580	10	Shadow	466521	8
Pick	466224	7	Sheen	466246	8

Textiles Graded-in sorted by pattern name: **Maharam**

Pattern Name	Pattern No.	Group	Pattern Name	Pattern No.	Group
Shift	466527	12	Vases	466164	11
Sift	466479	12	Veer	466497	8
Silk Canvas	465985	13	Velvet Stripe	466279	15
Slumber	466365	14	Vineyard	466133	11
Small Dot Pattern	458320	14	Voyage	456801	14
Soft Tweed	466197	13	Washi	466545	13
Songbird	466523	15	Waver	466459	8
Sort	466273	8	Wend	466381	8
Span	466395	9	Willow	466542	8
Spare	466465	13	Wool Check	466501	14
Spindel	466578	13	Wide Corduroy	466552	14
Splay	466448	8	Wool Rib	466198	13
Spry	466414	7	Wool Striae	466184	15
Stature	466180	8	Wool Velvet	466120	15
Steady Crypton	465946	9			
Stripes	463980	15			
Strum	466122	9			
Study	466269	11			
Sudden	463000	9			
Sundry	466441	11			
Superweave	466241	15			
Swathe	466416	12			
Switch	466515	9			
Swivel	466374	9			
Tangram	466084	13			
Taper	466413	12			
Taut Linen	466530	14			
Teatro	466309	12			
Tempera	466426	9			
Tend	466352	9			
Terra	466572	12			
The Firm	465999	15			
The Story of My Life	464670	14			
Toostripe	462260	14			
Tracery	466372	11			
Trait	464830	9			
Trellis	466244	8			
Tress	466529	14			
Trio	466088	11			
Trundle	466434	6			
Unisol	461160	14			
Valor	466491	13			

Textiles Graded-in sorted by Grading Group: **Kvadrat**

Group & Price/yard	Pattern Name	Group & Price/yard	Pattern Name
Group 1:52		Group 9: 188	Steelcut Trio
Group 2:65			Still
Group 3:81			Tonus
Group 4:92			Twill Weave
Group 5: 106		Group 10: 219	Ara
Group 6: 119			Atrium Outdoor
Group 7: 138	Haku		Colline 2
Group 8: 163	Basel		Fiord 2
	Canvas 2		Foss
	Clara		Hallingdal
	Hero		Harald 3 (RAF)
	Molly 2		Highfield 3
	Patio		Phlox (RAF)
	Reflect		Rime
	Remix		Sunniva 2 (RAF)
	Re-Wool	Group 11: 256	Lila
	Tonica 2		Mizmaze
Group 9: 188	Atlas		Technicolor Fleck
	Broken Twill Weave	Group 12: 294	Balder 3 (RAF)
	Divina 3		Coda
	Divina MD		Planum
	Divina Melange		Plecto by Febrik
	Encircle		Tambourine Hallingdal
	Field 2		Uniform by Febrik
	Floyd	Group 13: 375	Apparel by Febrik
	Galaxy		Drop by Febrik
	Glow		Husk by Febrik
	Jaali		Mosiac by Febrik
	Maple		Razzle Dazzle by Febrik
	Melange Nap		Spindel
	Memory		Sprinkles by Febrik
	Parkland		Triangle by Febrik
	Pro 3		Vidar 3 (RAF)
	Raas		Washi
	Recheck		Waterborn
	Revive 1	Group 14: 438	Atom (RAF)
	San		Byram (RAF)
	Savanna		
	Steelcut 2		

Textiles Graded-in sorted by Grading Group: **Kvadrat**

Group & Price/yard	Pattern Name
Group 14: 438	Crystal Field
	Fuse (RAF)
	Gentle 2.1 by Febrik
	Letters
	Pilot (RAF)
	Reflex (RAF)
	Sonar 3 (RAF)
Group 15: 563	Ria (RAF)
	Silas (RAF)

Textiles Graded-in sorted by Grading Group: **Maharam**

Group & Price/yard	Pattern Name	Number	Group & Price/yard	Pattern Name	Number
Group 1: 52			Group 7: 138	Spry	466414
Group 2: 65	Manner	466177	Group 8: 163	Bluff	466489
	Meld	466387		Boundary	466193
	Messenger	458640		Buffer	466492
	Metric	466014		Candor	466496
	Muse	466487		Chime	465350
Group 3: 81	Article	458600		Coast	466439
	Lariat	440401		Cycle	466275
	Medium	463490		Enmesh	466338
	Merit	466444		Frequency	466504
	Mode	466337		Gallant	466485
Group 4: 92	Metaphor	466553		Gild	466432
	Murmur	466446		Gust	466519
Group 5: 106	Dwell	466419		Instill	466351
	Milestone	403901		Keen	466433
Group 6: 119	Brindle	466418		Lean	466438
	Bureau	466472		Ledger	463770
	Elm	466557		Lens	466323
	Glen	466534		Levity	466518
	Lunar	466356		Loop	466469
	Mantle	466517		Motley	466360
	Pallet	466531		Pepper	466486
	Roster	466445		Pitch	466186
	Trundle	466434		Plait	466052
Group 7: 138	Caper	466384		Prompt	466493
	Coin	466233		Quay	466390
	Conduit	466428		Queue	466443
	Emit	466378		Rill	466370
	Fathom	466013		Ruote	466544
	Lineage	466127		Scuba	464930
	Micro	466099		Scute	466396
	Multiply	466341		Scuttle	466429
	Nico	466564		Shadow	466521
	Orbit	466415		Sheen	466246
	Pick	466224		Sort	466273
	Runner Standard	466167		Splay	466448
				Stature	466180
				Veer	466497
				Waver	466459
				Wend	466381
				Willow	466542

Textiles Graded-in sorted by Grading Group: **Maharam**

Group & Price/yard	Pattern Name	Number	Group & Price/yard	Pattern Name	Number	
Group 9: 188	Abacus	466118	Group 9: 188	Tempera	466426	
	Beck	466570		Tend	466352	
	Beryl	466508		Trait	464830	
	Brio	466386		Group 10: 219	Beacon	466405
	Bushel	466490			Brim	466350
	Bushel	466490			Campana	466571
	Chasm	466404			Chalet	466324
	Chassis	466458			Crew	466149
	Circuit	466089			Cursive	466335
	Clamber	466385			Drape	466145
	Column	466192			Firma	466582
	Compound	466196			Flint	466543
	Cosset	466524	Fold		466292	
	Crush	464780	Gemma		466568	
	Ellipsis	466334	Gemma Multi		466569	
	Embed	466457	Insignia		466308	
	Equate	466383	Link		466328	
	Feature	466343	Mister		466178	
	Festoon	466525	Petra		466580	
	Fluent Crypton	466073	Regatta		466189	
	Grove	466344	Rule		466190	
	Jasper	466563	Scape		466357	
	Linden	466537	Serried		466408	
	Lithe	466394	Trellis	466244		
	Luce	466566	Group 11: 256	Ample	466532	
	Nimble	466488		Anagram	466067	
	Pare	466359		Apt	1356	
	Pick Crypton	466235		Arcade	466447	
	Pinnacle	466503		Bright Angle	466331	
	Pocket	466243		Bright Cube	466329	
	Prime	466436		Bright Grid	466330	
	Province	466549		Entwine	466397	
Rail	466535	Hewn		466398		
Runner	466108	Lift		466302		
Sendal	466550	Limn		466407		
Sequence	466179	Mechanism		465952		
Span	466395	Mexidot	466441			
Steady Crypton	465946	Mimic	466136			
Strum	466122	Offset	465951			
Sudden	463000	Study	466269			
Switch	466515					
Swivel	466374					

Textiles Graded-in sorted by Grading Group: **Maharam**

Group & Price/yard	Pattern Name	Number	Group & Price/yard	Pattern Name	Number
Group 11: 256	Sundry	466441	Group 13: 375	Silk Canvas	465985
	Tracery	466372		Soft Tweed	466197
	Trio	466088		Spare	466465
	Vases	466164		Tangram	466084
	Vineyard	466133		Valor	466491
Group 12: 294	Amulet	466482	Group 14: 438	Wool Rib	466198
	Bind	466437		Arabesque	466204
	Darning Sampler	466460		Aria	459950
	Darning Sampler Large	466461		Bander	466442
	Garden	466134		Checker	459830
	Hearth	466536		Checker Split	460290
	Imbue	466375		Circles	458310
	Mesh	466371		Circles	466475
	Monsoon	466481		Coach Cloth	458950
	Pepitas	466576		Cotton Velvet	466199
	Range	466583		Crosspatch	458920
	Reef	466332		Dot Pattern	458300
	Relay	466453		Double Triangles	459840
	Roman	466565		Exaggerated Plaid	466039
	Shift	466527		Facets	459850
	Sift	466479		Fluted Silk	465982
	Swathe	466416		Geometri	459970
	Taper	466413		Glaze	466506
	Teatro	466309		Fore	466464
	Terra	466572		Glaze	466506
Group 13: 375	Albemarle	466435	Idle	466466	
	Confetti	466203	Jacobs Coat	462270	
	Cove	466526	Mela	466483	
	Darning Sampler Plaid	466462	Melange Tweed	461190	
	Dingbats	465994	Mikado	459330	
	Dots	466411	Millerstripe	462250	
	Edges	466476	Minicheck	466268	
	Etch	466502	Names	462510	
	Flurry	466480	Nestle	466388	
	Fore	466464	Optik	459960	
	Fruit	466262	Overlapping Stripe	466495	
	Houndstooth	466253	Painted Stripe	465998	
	Inlay	466353	Parched Silk	465974	
	Palio	466107	Plume	466382	
	Segmented Stripe	466373	Point	466090	
			Quatrefoil	459340	

Textiles Graded-in sorted by Grading Group: **Maharam**

Group & Price/yard	Pattern Name	Number	Group & Price/yard	Pattern Name	Number
Group 14: 438	Quell	466366	Group 15: 563	Roam	466520
	Repeat Classic Stripe	462170		Sequential Stripe	466377
	Repeat Dot Ring	462150		Songbird	466523
	Slumber	466365		Stripes	463980
	Small Dot Pattern	458320		Velvet Stripe	466279
	Taut Linen	466530		Wool Striae	466184
	The Story of My Life	464670		Wool Velvet	466120
	Toostripe	462260			
	Tress	466529	Not Graded	A Band Apart	466000
	Unisol	461160		Agency	466001
	Voyage	456801		Alpaca Epingle	465902
	Wide Corduroy	466552		Alpaca Velvet	465901
	Wool Check	466501		Assembled Check	466345
				Bavaria	466162
Group 15: 563	Angles	466477		Borders	466082
	Bavaria Stripe	466161		Brushed Camel	465977
	Bespoke Stripe	463540		Brushed Cashmere	465978
	Big Stripe	466174		Brushed Merino	465983
	Blended Stripe	466412		Cashmere Ripple	465979
	Blumen	462870		Chroma	466303
	Croft	466498		Colorfield	466315
	Design 9297	465230		Compartment	466154
	Epingle Stripe	466007		Deconstructed Rose	466086
	Flutter	466430		Eden	466258
	Herringbone Stripe	465945		Foliage	466257
	Huddle	466420		Grid	466210
	Layers Garden	465916		Horsehair Basket	465981
	Layers Park	465918		Horsehair Check	465980
	Layers Vineyard Large	465921		Horsehair Striae	465984
	Layers Vineyard Small	465920		Hours	466092
	Linen Basket	466541		Industry	466255
	Mingled Plaid	466364		Lanalux	466240
	Mohair Supreme	451801		Layers Garden Double	465917
	Monk's Wool	457301		Layers Park Double	465919
	Orakelblume	463900		Massive Paisley	465915
	Ottoman Stripe	466142		Repeat Classic	462100
	Paisley Brocade	466559		Repeat Classic Print	462160
	Passel	466470		Repeat Dot	462110
	Pebble Wool	457401		Repeat Dot Print	462130
	Pebble Wool Multi	461200		Superweave	466241
	Pressed Linen	466380		The Firm	465999
	Pressed Plaid	466181			

Corian Solid Surface Schedule sorted by Grading Group

Group 1	Abalone Bisque Bone Cameo White Glacier White Linen Maui Sahara Sandstone Silver Gray Vanilla	Group 4	Deep Caviar Deep Mink Deep Night Sky Dove Flint Fossil Granola Pine Raffia Rice Paper Royal Red Seafoam Serene Sage Suede Venaro White Whisper White Jasmine	Group 5	Whipped Cream Willow	Group 7	Minera Nimbus Prima Sagebrush Sand Storm Smoke Drift Prima Sonora Stardust White Onyx Windswept Prima
Group 2	Antarctica Aurora Blue Pebble Canyon Cocoa Brown Designer White Modern White Mojave Sand Savannah Stratus Summit White	Group 5	Anthracite Ash Concrete Blue Spice Carbon Concrete Cilantro Deep Anthracite Deep Bedrock Deep Cloud Deep Espresso Deep Nocturne Deep Sable Deep Space Deep Storm Deep Titanium Doeskin Fawn Glacier Ice Matterhorn Neutral Concrete Oat Silver Birch Silverite Weathered Concrete	Group 6	Arrowroot Basil Clam Shell Cool Gray Cosmos Prima Earth Gray Onyx Hazelnut Jasmine Keystone Lava Rock Limev Prima Natural Gray Rain Cloud Riverbed Rosemary Saffron Sandalwood Sorrel Tumbleweed Witch Hazel		
Group 3	Elegant Gray Everest Moss Nightfall Pearl Gray Platinum Silt Sparkling White			Group 7	Allspice Aqualite Burlled Beach Cocoa Prima Deep Inkwell Deep Lapis Deep Smoky Pear Deep Terrain Dune Prima Ecru Elderberry Evening Prima Graylite Hickory Smoke Juniper Milky Way		
Group 4	Arctic Ice Bronzite Canvas Cobalt Concrete Cottage Lane Deep Black Quartz						

