

memo

Pricelist
2023 / Q2

memo

Contents

page 3 Terms of Sale
page 4 Limited Lifetime Warranty
page 5 Customer Service
page 6 Finishes Overview
page 8 Textiles Overview

page 12 April Seating

page 12 Side Chair
page 13 Counter Stool
page 14 Bar Stool

page 15 Chord Tables

page 15 Personal Table
page 17 Side Table
page 19 Coffee Table

page 21 Chroma Seating

page 21 Lounge
page 22 Lounge Armless
page 23 Lounge Swivel
page 24 Ottoman - 17
page 25 Ottoman - 24
page 26 Ottoman - 29
page 27 Ottoman - 38

page 28 Ida

page 28 Ida

page 29 Kino

page 29 Kino

page 31 Maru Benches

page 31 Three Slat Bench, 3/4 Length
page 33 Three Slat Bench
page 35 Five Slat Bench
page 38 Seven Slat Bench

page 41 Orca Screens

page 41 Vertical Screen
page 43 Horizontal Screen

page 45 Penna Seating

page 45 Penna Lounge

page 46 Penna Tables

page 46 Large Round
page 47 Obround
page 48 Small Round
page 49 Bar Table
page 51 Café Table
page 53 Meeting Table
page 55 Height Adjustable Cafe table 24-42, 48 diameter
page 57 Height Adjustable Meeting table 24-42, 54 diameter
page 59 Height Adjustable Cafe table 29-42, 48 diameter
page 61 Height Adjustable Meeting table 24-42, 54 diameter

page 63 Prose Seating

page 63 Side Chair with Arms
page 65 Plus Chair
page 67 Settee
page 69 Lounge
page 71 Loveseat

page 73 Rolo Seating

page 73 Lounge
page 74 Loveseat
page 75 Sofa

page 76 Rolo Tables

page 76 Side Table
page 77 Coffee Table

page 78 Materials & Finishes Schedules

page 78 Textiles Schedule
page 80 Corian Solid Surface Schedule

Terms of Sale

Pricing Policy

All prices shown for products and accessories are manufacturer's suggested list price. Prices shown do not include freight, surcharges, appropriate taxes, crating (if applicable), storage, or installation charges. Memo reserves the right to amend price lists, change designs, and discontinue or add models without prior notice. Price list of latest date supersedes and cancels all previous lists. All orders accepted are subject to prices upon receipt of order.

Payment Terms

Except as otherwise specified, all orders require a 50% deposit with the balance due with thirty (30) days from the invoice date. All payments are payable in U.S. dollars. Lead times start after the receipt of deposit. Payments not made by the due date may incur, at the sole discretion of Memo, a late payment service charge of 1.5% per month. All payments and deposits are non-refundable.

Changes and Cancellations

Customers will receive a written confirmation of pricing, credit terms and estimated completion date. Changes to orders or cancellations made after production has begun will carry extra charges based on expenses incurred.

Shipping

Standard cartoning and standard surface freight to any point within the 48 contiguous United States is included in Memo quotes as a separate charge independent of product price. For shipments to Alaska, Hawaii and International destinations, additional shipping and handling charges will apply. Orders are shipped cartoned as standard. If crating is requested or required, additional charges will apply and a custom quote will be provided. Service add-ons for freight will also include additional charges as follows:

Gate Lift : \$125 NET

Residential Delivery : \$150 NET

Delivery Appointment in Advance: \$100 NET

Any additional freight charges will be provided at the time of quote. From time to time, market conditions for fuel and/or labor may result in freight surcharges, beyond our standard rates. In these cases, surcharges will be indicated on all quotes.

Freight Claims

Product is shipped FOB Factory, freight prepaid and allowed via truck. The title of goods changes to the purchaser when merchandise leaves Memo's dock. All shipments are transferred to the transportation company in good condition.

Receiver and/or specifier are required to inspect cartons and product upon receipt and note the condition and any damage or shortage on the Bill of Lading upon delivery. Receiver and or specifier are required to notify Memo and the carrier of evident damage or product shortages at time of delivery and request an inspection. Failure to report evident damage or product shortages within (3) business days of delivery will be considered total and full acceptance of goods as is. In the case of shipping damage, the receiver and/or specifier is to provide Memo with photographs of the damaged carton/packaging and goods. Photographs are required for Memo to process and award if approved, any claims for recovery. Shipping cartons and packaging should be retained for carrier inspection and the damaged product should be kept in the receiving location. If the freight carrier will not perform the inspection, receiver and/or specifier should prepare an affidavit; noting that the freight company refused to comply with an inspection - citing date and time.

Any concealed damage claims against Memo for apparent damages must be made by the purchaser and or specifier in writing within five (5) business days of delivery, including a copy of the BOL and photographs of the carton/ packaging and damaged goods. Failure to notify Memo within 5 business days of receipt shall constitute acceptance of the product and waiver of any apparent damages resulting in replacement and or repair of damaged goods being billed to the purchaser.

Any relevant damage or shortages to blanket wrapped shipments must be noted on the Bill of Lading at the time of delivery.

Custom Requests

Requests to modify existing products (Modifications) or to produce ground-up solutions (Specials) should be submitted to our customer service group, at which time they will be assessed and submitted for design and engineering approval. All custom requests will elicit a receipt and a response will be provided within 48 hours of receipt. Upon approval, a price and lead-time quote will be generated and provided for customer review and acceptance.

Limited Lifetime Warranty

Memo Furniture warrants its products, to the original user and for the original purpose, to be free of defects in design, material and workmanship, given normal use and care for the lifetime of the product from the date of invoice. This warranty does not include damage from accident, alteration, misuse, normal wear and tear, transportation or improper installation and maintenance.

During the warranty period, Memo Furniture, at its option, will repair or replace any product which, upon inspection by Memo Furniture or its designated representative, is deemed to be defective in materials or workmanship and is covered by this warranty.

This warranty does not apply to defects in components not manufactured by Memo Furniture. In these cases, the warranty period provided by the supplier of the component will apply. The liability of Memo Furniture is limited to furnishing new parts as may be necessary to replace any item that may prove to be defective in material or workmanship. Memo Furniture will make every effort to replace parts if they are available from the supplier of those parts. We will not assume liability of charges for labor, consequential expenses or damages incurred.

Textiles and leathers are not warranted against fading or normal wear, customer induced cuts or tears or irregularities in the registration of printed textile patterns. Due to natural variations, in which Memo Furniture has no control, this warranty does not extend to color, grain, texture or the durability or suitability of any exterior surface coatings or treatments.

This warranty is void in cases of damage in transit, negligence, abuse, abnormal usage, misuse, accidents, and improper cleaning and maintenance. Normal aging and wear of woven and non-woven upholstery are exempt from this warranty.

All other warranties, expressed or implied, are excluded. Memo Furniture shall not be liable for incidental or consequential damages of any sort.

If you have any questions or wish to file a claim against this warranty, please contact Customer Service at +1 206 995 8780.

Customer Service

Memo's Customer Service Group is trained to assist with quotes, orders, custom requests, product details, warranty inquires, and to answer general questions.

We can be reached Monday through Friday, 7:00 am – 5:00 pm Pacific Time, directly via email at service@memofurniture.com or via our voicemail line at +1 206 995 8780.

Inquiries received after-hours via voicemail or email will receive a response before the close of business on the following business day.

Please visit www.memofurniture.com for answers to most questions including product prices, specifications, photos, SketchUp and Revit files, and marketing material.

Please visit our quote tool <https://staging-quotes.memofurniture.com> for 24/7 live access to quotes and our configurator. Additionally, a local sales representative can assist you further. Contact names and numbers are also available on our website.

Finishes

Memo offers a range of proprietary colors and finishes on select materials, as well as support for a broad range of open line laminates and solid surface. Our finishes have been curated to offer a foundation of essential base neutrals, to which accents and stronger colors can be added.

Memo offers finish and pattern selections in the following materials:

Forbo Furniture Linoleum

Memo offers Forbo furniture-grade linoleum on select products. Forbo is a durable surface material, available in a dynamic range of colors. Derived from solidified Linseed Oil and other natural fillers such as cork and wood dust, Forbo is a sustainable and resilient surface choice.

Metal Powder Coat

Our powder coats are applied to both steel and aluminum, and are available in textured and smooth finishes. Powder coating is extremely durable and emits zero pollutants once cured.

Natural Stone

Memo offers natural stone on select table and horizontal surface tops. Our stone is hand selected from the highest quality slabs however natural variances will occur from product to product.

Solid Surface

Memo offers Corian and Wilsonart solid surface options on certain products. Solid Surface, is a non-porous high durability product that is stain resistant, easy to clean, and easily repairable.

Wood & Veneer

Our products utilize both solid wood and wood veneer, and are offered in either Ash, Beech or Walnut depending on the product. Products with edge profiles will include a matching wood edge. Wood products are finished in a resilient, long lasting, conversion varnish.

Memo Colors and Finishes

Metal Powder Coat

Steel Gray Gloss	MSG
Med Bronze Gloss	MMB
Black Texture	MBT
Silver Metallic Gloss	MSM
Yellow Leaf Gloss	MYL
Copper Red Matte	MCR
Sage Green Matte	MGG
Navy Blue Matte	MNB

Natural Stone

White Gray Marble	RWM
-------------------	-----

Solid Surface (Wilsonart)

Black Onyx Mirage	STS-BLS
Hidden Spaces	STS-HIS
Kimberlite	STS-KIS
Yukon Riverstone	STS-YUS

Wood & Veneer

Clear over Ash	WCA
Oak Over Ash	WOA
Gray Over Ash	WGA
Walnut Over Ash	WWA
Clear Over Beech	WCB
Clear Over Walnut	WCW
Navy Painted Wood	WNP

Painted Wood

Blood Orange	PBO
Cashew Yellow	PCY
Cream White	PCW
Dusty Pink	PDP
Forest Green	PFG
Ocean Blue	POB
Stone Gray	PSG

Memo Supported Open-Line Finishes

Corian

Memo offers open line Corian solid surface options on the Prose Collection. For a list of Corian products by grade see page 76.

Forbo Furniture Linoleum

Ash - 4132	FAS
Burgundy - 4154	FBU
Iron - 4178	FIR
Pebble - 4175	FPE
Pewter - 4155	FPW
Powder - 4185	FPO
Smokey Blue - 4179	FSB

Textiles

Graded-in Textiles

Memo has partnered with Camira, Kvadrat, and Maharam to offer graded-in textiles. All graded-in textiles are listed by Pattern Name on page 77 and by Grading Group on page 78. Our Grading Groups and their LIST prices per yard are outlined below. Published product prices, including the cost of Graded-in Textiles, have been calculated by multiplying by the price per yard figures below by the yardage requirements indicated on a given product page.

Grading Group	LIST Price per Yard
1	48
2	59
3	74
4	84
5	95
6	109
7	126
8	144
9	165
10	193
11	228
12	263
13	315
14	389
15	463

Memo is glad to grade in textiles from suppliers other than Camira, Kvadrat, and Maharam per customer requests. A grading fee of \$200 NET per pattern, per product, will apply in such cases. Please contact us to submit grading requests.

When specifying graded-in textiles the projected completion date of your order may exceed our normal lead times due to constraints of the textile supplier. In such instances, Memo will promptly communicate such delays and advise on adjusted lead times.

Textiles are subject to the quality and shipping standards of the provider. Memo assumes no responsibility for defects, color inaccuracies, shortages, wear, or performance of textiles.

Ordering a Textile Sample

Samples can be ordered by visiting the textile provider's website.

Textiles

Customer's Own Material (COM)

While we recommend selecting from our graded-in Camira, Kvadrat, and Maharam textile offer for the most streamlined process, we also provide the option to use COM. Memo, however, reserves the right to reject textiles which are unsuitable for upholstery on our products. This may be due to inadequate textile weight or unique elastic qualities which impact the integrity of upholstery on our products.

To select fabric outside of the graded-in fabric program, a few steps are required. Memo provides the total yardage for each product on its product spec sheets and pricelist reference pages. These published yardage figures are based on the application conditions of the cutting pattern for each product as well as managing quality issues. Certain textiles, depending on their width and/or repeat, may require additional yardage beyond the figures in our pricing pages. To calculate additional yardage, see our guidelines on page 11. Memo will also provide yardage requirements upon receipt of an order.

Upon receipt of the textile, Memo will immediately advise if flaws or deficiencies in the order are discovered. Memo assumes no responsibility for defects, color inaccuracies, shortages, wear, or sub-standard performance of the specified textiles.

Note that Memo will dispose of excess upholstery material at the time of shipment unless expressly requested to return it with the product shipment.

Customer's Own Leather (COL)

Please contact our customer service group at info@memofurniture.com or +1 206 995 8780.

Textiles**Delivery of Customer's Own Material (COM)**

Customers are responsible for ensuring delivery of COM fabric to Memo. Orders for COM-upholstered products will be scheduled into production upon receipt of all COM and swatches. Please work with our customer service group to procure written confirmation of textile supplier ship dates to ensure the best possible lead time. Since shipment of COM orders depends upon textile availability, lead times may vary.

When supplying COM textiles to Memo, please include the following info:

Textile supplier

Pattern name and number

Color name and number

A representative fabric swatch for identification purposes with face side marked

Any nonstandard treatments applied to the fabric

Any additional documentation

All COM or COL must be sent prepaid to the following address and tagged as follows:

Kaas Tailored c/o Memo Furniture

13000 Beverly Park Road, Suite A

Mukilteo, WA 98275

Attn: Receiving Department

Dealer name

P.O. #

Order code # (for each fabric)

Textiles**Order Requirements for Customer's Own Material (COM)**

Memo reserves the right to reject textiles or materials. Textiles requiring secondary backing or coatings should be treated prior to shipping to Memo. All yardage figures listed in Memo product spec sheets and pricelist reference pages are based on at least 54" Wide, Plain Fabric.

Increases for Textile Width and/or Repeat

In the event that COM textile is both less than 54" wide and also has a repeat, add both of the two increases shown below. For textiles that require matching (stripes, plaids, prints, pattern repeats) it is Memo's policy to match all pattern repeats, stripes, prints or plaids unless specified 'No Matching Required' on purchase order.

Fabric Bolts Less than 54" Wide

Less than 54" wide	Add 08%
Less than 50" wide	Add 13%
Less than 48" wide	Add 20%
Less than 45" wide	Add 50%
Less than 36" wide	Add 60%

Fabrics with Repeats

Repeat 7" & less	Add 11%
Repeat 13" & less	Add 18%
Repeat 21" & less	Add 21%
Repeat 27" & less	Add 24%
Repeat more than 27"	Add 25%

Order Requirements for Customer's Own Leather (COL)

COL orders are based on an average hide size of 45 square feet of usable leather and 19 feet per yard. Due to shape and quality issues with some leather, additional hides may be required after receipt of COL. Ship full hides only.

To convert COM yardage requirements to COL square footage and number of hides, multiply the COM yardage by 19.

Example: 5 yards x 19 = 95 square feet.

April

Side Chair

Designed by Jun Yasumoto, 2022

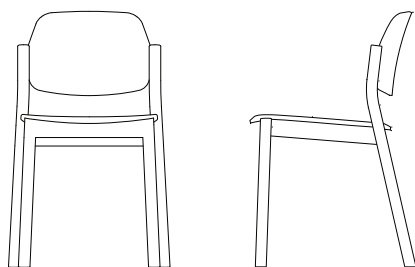

Depth	Width	Height
19.5	19.25	30.75

Core Product	Core Code	List Price
Side Chair - Beech	JY02-10	870

Standard with Core Product

Non-marring Glides

List Price by Textile Grade*

	COM / 1	2	3	4	5	6	7	8	9	10	11	12	13	14	15
JY02-10-UPH	1103	1112	1123	1130	1139	1149	1162	1175	1191	1212	1237	1265	1304	1359	1415

Options	Code	List Price Add
Upholstered Seat	UPH	See above
Clear Over Beech	WCB	0
Stain Finishes	WGB/WOB/WWB/WBB	74
Painted Wood	PEW/PCY/PFG/POB/PBO/PSG/PDP	100

Notes

For step-by-step specifications and quotes, access our live quote tool online at → [Quotes](#)

April

Counter Stool

Designed by Jun Yasumoto, 2022

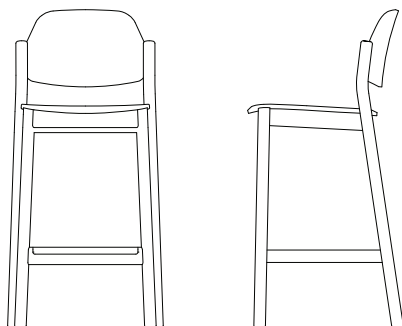

Depth	Width	Height
18	18.5	38

Core Product	Core Code	List Price
Counter Stool - Beech	JY02-16	960

Standard with Core Product

- Glides
- Stainless Steel Footrail

List Price by Textile Grade*

	COM / 1	2	3	4	5	6	7	8	9	10	11	12	13	14	15
JY02-16-UPH	1193	1202	1213	1220	1229	1239	1252	1265	1281	1302	1327	1355	1394	1449	1505

Options	Code	List Price Add
Upholstered Seat	UPH	See above
Clear Over Beech	WCB	0
Stain Finishes	WGB/WOB/WWB/WBB	86
Painted Wood	PEW/PCY/PFG/POB/PBO/PSG/PDP	113

Notes

For step-by-step specifications and quotes, access our live quote tool online at → [Quotes](#)

April

Bar Stool

Designed by Jun Yasumoto, 2022

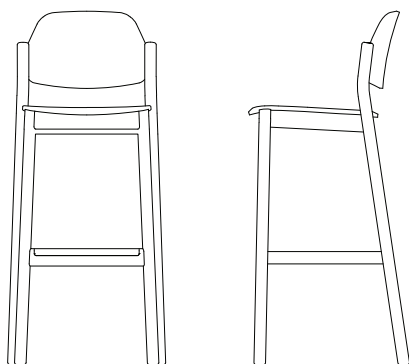

Depth	Width	Height
18	18.75	42.25

Core Product	Core Code	List Price
Bar Stool - Beech	JY02-17	989

Standard with Core Product

- Glides
- Stainless Steel Footrail

List Price by Textile Grade*

	COM / 1	2	3	4	5	6	7	8	9	10	11	12	13	14	15
JY02-17-UPH	1222	1231	1242	1249	1258	1268	1281	1294	1310	1331	1356	1384	1423	1478	1534

Options	Code	List Price Add
Upholstered Seat	UPH	See above
Clear Over Beech	WCB	0
Stain Finishes	WGB/WOB/WWB/WBB	89
Painted Wood	PEW/PCY/PFG/POB/PBO/PSG/PDP	116

Notes

For step-by-step specifications and quotes, access our live quote tool online at → [Quotes](#)

Chord

Personal Table

Designed by Standard Issue, 2019

Made in the USA.

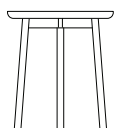
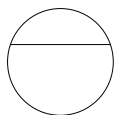

Depth	Width	Height
18"	18"	20.5"

Core Product

Personal Table

Core Code

MM01-T1

List Price

965

Standard with Core Product

Glides

Open Tray Surface

Powder Coated Steel Frame

Options

	Code	List Price Add
Large Insert Options		
Forbo Linoleum	FTL	486
Wood Veneer (Ash)	VAL	568
Clear Finish	WCA/WCW	0
Stain Finish	WOA/WWA/WGA/WNP	38
Wood Veneer (Walnut)	VWL	622
Small Insert Options		
No Insert (void)	XXS	0
Forbo Linoleum	FTS	12
Wood Veneer (Ash)	VAS	40
Clear Finish	WCA/WCW	0
Stain Finish	WOA/WWA/WGA/WNP	38
Wood Veneer (Walnut)	VWS	63
Solid Surface		
Yukon Riverstone	STS-YUS	345
Black Onyx Mirage	STS-BLS	345
Hidden Space	STS-HIS	345
Kimberlite	STS-KIS	443

Specifiable Finishes

Linoleum	Choose from Forbo linoleum products on page 7
Metal	Choose from Memo Metal Powder Coat Finishes on page 7
Wood	Choose from Memo Wood Finishes on page 7
Solid Surface	Choose from Memo Solid Surface Finishes on page 7

Notes

For step-by-step specifications and quotes, access our live quote tool online at → [Quotes](#)

Chord

Side Table

Designed by Standard Issue, 2019

Made in the USA.

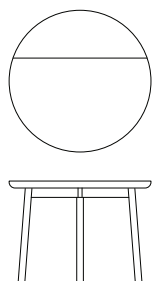

Depth	Width	Height
24"	24"	17.25"

Core Product

Side Table

Core Code

MM01-T2

List Price

1059

Standard with Core Product

Glides

Open Tray Surface

Powder Coated Steel Frame

Options

	Code	List Price Add
Large Insert Options		
Forbo Linoleum	FTL	551
Wood Veneer (Ash)	VAL	711
Clear Finish	WCA/WCW	0
Stain Finish	WOA/WWA/WGA/WNP	57
Wood Veneer (Walnut)	VWL	796
Small Insert Options		
No Insert (void)	XXS	0
Forbo Linoleum	FTS	18
Wood Veneer (Ash)	VAS	45
Clear Finish	WCA/WCW	0
Stain Finish	WOA/WWA/WGA/WNP	57
Wood Veneer (Walnut)	VWS	74
Solid Surface		
Yukon Riverstone	STS-YUS	404
Black Onyx Mirage	STS-BLS	404
Hidden Space	STS-HIS	404
Kimberlite	STS-KIS	559

Specifiable Finishes

Linoleum	Choose from Forbo linoleum products on page 7
Metal	Choose from Memo Metal Powder Coat Finishes on page 7
Wood	Choose from Memo Wood Finishes on page 7
Solid Surface	Choose from Memo Solid Surface Finishes on page 7

Notes

For step-by-step specifications and quotes, access our live quote tool online at → [Quotes](#)

Chord

Coffee Table

Designed by Standard Issue, 2019

Made in the USA.

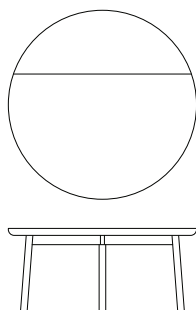

Depth	Width	Height
32"	32"	14.25"

Core Product

Coffee Table

Core Code

MM01-T3

List Price

1251

Standard with Core Product

Glides

Open Tray Surface

Powder Coated Steel Frame

Options

	Code	List Price Add
Large Insert Options		
Forbo Linoleum	FTL	646
Wood Veneer (Ash)	VAL	894
Clear Finish	WCA/WCW	0
Stain Finish	WOA/WWA/WGA/WNP	76
Wood Veneer (Walnut)	VWL	1027
Small Insert Options		
No Insert (void)	XXS	0
Forbo Linoleum	FTS	37
Wood Veneer (Ash)	VAS	47
Clear Finish	WCA/WCW	0
Stain Finish	WOA/WWA/WGA/WNP	76
Wood Veneer (Walnut)	VWS	81
Solid Surface		
Yukon Riverstone	STS-YUS	638
Black Onyx Mirage	STS-BLS	638
Hidden Space	STS-HIS	638
Kimberlite	STS-KIS	904

Specifiable Finishes

Linoleum	Choose from Forbo linoleum products on page 7
Metal	Choose from Memo Metal Powder Coat Finishes on page 7
Wood	Choose from Memo Wood Finishes on page 7
Solid Surface	Choose from Memo Solid Surface Finishes on page 7

Notes

For step-by-step specifications and quotes, access our live quote tool online at → [Quotes](#)

Chroma

Lounge

Designed by Harri Koskinen, 2019

Made in the USA.

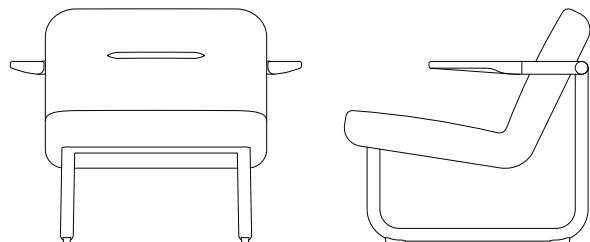

Depth	Width	Height
28.75"	33.75"	27.5"

Core Product

Lounge

Core Code

HK01-01

Textile Yardage

Total: 2.0

Seat	Back	Arms
n/a	n/a	n/a

List Price by Textile Grade

	COM / 1	2	3	4	5	6	7	8	9	10	11	12	13	14	15
HK01-01	3243	3265	3295	3315	3337	3365	3399	3435	3477	3533	3599	3673	3777	3925	4073

Standard with Core Product

Ash Arms

Non-Marring Glides

High Resilience Polyurethane Foam

Options

Component

Ash Arms with Stain
Walnut Arms

Code

WOA/WWA/WGA/WNP
WCW

List Price Add

57
212

Specifiable Finishes

Metal

Choose from Memo Metal Powder Coat Finishes on page 7

Textiles

Choose from Camira, Maharam, or Kvadrat textiles on page 74, or contact Memo for assistance with COM fabrics

Wood

Choose from Memo Wood Finishes on page 7

Notes

Due to the continuous seat and back, multiple textiles are not permitted on Chroma Lounge

For step-by-step specifications and quotes, access our live quote tool online at → Quotes

Chroma

Lounge, Armless

Designed by Harri Koskinen, 2019

Made in the USA.

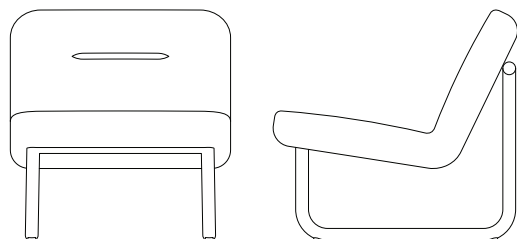

Depth	Width	Height
28.75"	26"	27.5"

Core Product

Lounge, Armless

Core Code

HK01-09

Textile Yardage

Total: 2.0

Seat	Back	Arms
n/a	n/a	n/a

List Price by Textile Grade

	COM / 1	2	3	4	5	6	7	8	9	10	11	12	13	14	15
HK01-09	2676	2698	2728	2748	2770	2798	2832	2868	2910	2966	3032	3106	3210	3358	3506

Standard with Core Product

Non-Marring Glides

High Resilience Polyurethane Foam

Specifiable Finishes

Metal

Choose from Memo Metal Powder Coat Finishes on page 7

Textiles

Choose from Camira, Maharam, or Kvadrat textiles on page 74, or contact Memo for assistance with COM fabrics

Notes

Due to the continuous seat and back, multiple textiles are not permitted on Chroma Lounge

For step-by-step specifications and quotes, access our live quote tool online at → Quotes

Chroma

Lounge, Swivel

Designed by Harri Koskinen, 2019

Made in the USA.

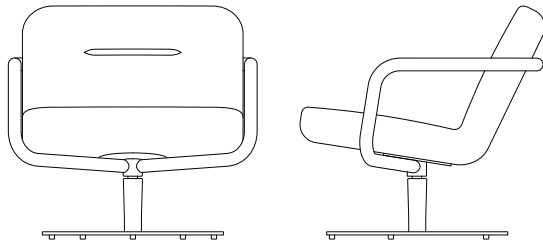

Depth	Width	Height
28.75"	29.25"	27.5"

Core Product

Lounge, Swivel

Core Code

HK01-11

Textile Yardage

Total: 2.0

Seat Back Arms

n/a n/a n/a

List Price by Textile Grade

	COM / 1	2	3	4	5	6	7	8	9	10	11	12	13	14	15
HK01-11	3535	3557	3587	3607	3629	3657	3691	3727	3796	3825	3891	3965	4069	4217	4365

Standard with Core Product

Free swivel base

High Resilience Polyurethane Foam

Non-Marring Glides

Specifiable Finishes

Metal Choose from Memo Metal Powder Coat Finishes on page 7

Textiles Choose from Camira, Maharam, or Kvadrat textiles on page 74, or contact Memo for assistance with COM fabrics

Notes

Due to the continuous seat and back, multiple textiles are not permitted on Chroma Lounge

For step-by-step specifications and quotes, access our live quote tool online at → Quotes

Chroma

Ottoman - 17

Designed by Harri Koskinen, 2019

Made in the USA.

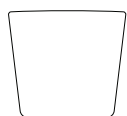
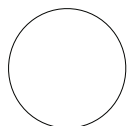

Depth	Width	Height
17.25"	17.25"	15.5"

Core Product

Ottoman

Core Code

HK01-00

Textile Yardage	Seat	Back	Arms
Total: 1.25	1.25	n/a	n/a

List Price by Textile Grade

	COM / 1	2	3	4	5	6	7	8	9	10	11	12	13	14	15
HK01-00	1109	1123	1142	1154	1168	1185	1207	1229	1255	1290	1332	1378	1443	1535	1628

Standard with Core Product

High Resilience Polyurethane Foam

Non-Marring Glides

Specifiable Finishes

Textiles Choose from Camira, Maharam, or Kvadrat textiles on page 74, or contact Memo for assistance with COM fabrics

Notes

For step-by-step specifications and quotes, access our live quote tool online at → Quotes

Chroma

Ottoman - 24

Designed by Harri Koskinen, 2019

Made in the USA.

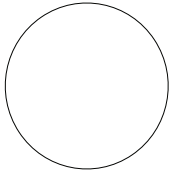

Depth	Width	Height
24"	24"	15.5"

Core Product

Ottoman

Core Code

HK01-24

Textile Yardage	Seat	Back	Arms
Total: 1.5	1.5	n/a	n/a

List Price by Textile Grade

	COM / 1	2	3	4	5	6	7	8	9	10	11	12	13	14	15
HK01-24	1450	1467	1489	1504	1521	1542	1567	1594	1626	1668	1717	1773	1852	1962	2073

Standard with Core Product

High Resilience Polyurethane Foam

Non-Marring Glides

Specifiable Finishes

Textiles Choose from Camira, Maharam, or Kvadrat textiles on page 74, or contact Memo for assistance with COM fabrics

Notes

For step-by-step specifications and quotes, access our live quote tool online at → [Quotes](#)

Chroma

Ottoman - 29

Designed by Harri Koskinen, 2019

Made in the USA.

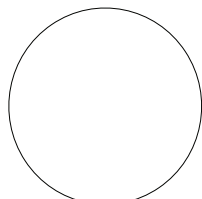

Depth	Width	Height
29"	29"	15.5"

Core Product

Ottoman

Core Code

HK01-29

Textile Yardage

Total: 2

Seat	Back	Arms
2	n/a	n/a

List Price by Textile Grade

	COM / 1	2	3	4	5	6	7	8	9	10	11	12	13	14	15
HK01-29	1675	1697	1727	1747	1769	1797	1831	1867	1909	1965	2031	2105	2209	2357	2505

Standard with Core Product

High Resilience Polyurethane Foam

Non-Marring Glides

Specifiable Finishes

Textiles

Choose from Camira, Maharam, or Kvadrat textiles on page 74, or contact Memo for assistance with COM fabrics

Notes

For step-by-step specifications and quotes, access our live quote tool online at → Quotes

Chroma

Ottoman - 38

Designed by Harri Koskinen, 2019

Made in the USA.

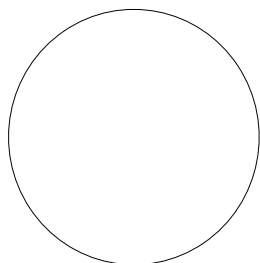

Depth	Width	Height
38"	38"	15.5"

Core Product

Ottoman

Core Code

HK01-38

Textile Yardage

Total: 2.25

Seat Back Arms

2.25 n/a n/a

List Price by Textile Grade

	COM / 1	2	3	4	5	6	7	8	9	10	11	12	13	14	15
HK01-38	2184	2209	2243	2265	2290	2321	2360	2400	2447	2510	2585	2668	2785	2951	3118

Standard with Core Product

High Resilience Polyurethane Foam

Non-Marring Glides

Specifiable Finishes

Textiles

Choose from Camira, Maharam, or Kvadrat textiles on page 74, or contact Memo for assistance with COM fabrics

Notes

For step-by-step specifications and quotes, access our live quote tool online at → Quotes

Ida

Table

Designed by Nina Cho, 2022

Made in the USA.

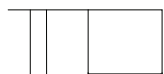
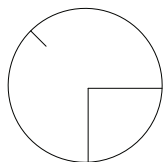

Depth	Width	Height
32"	32"	13.75"

Core Product	Core Code	List Price
Table	NC01-T1	4930

Options

	Code	List Price Add
Shelf Insert Options		
No Shelf Insert	XXS	0
Solid Wood Insert (Ash)	WAS	270
Solid Wood Insert (Ash + Stain)	WOA/WWA/WGA/WNP	90
Solid Wood Insert (Walnut)	WWS	420
Stone Insert (Marble)	STS	660

Specifiable Finishes

Metal	Choose from Memo Metal Powder Coat Finishes on page 7
Wood (shelf)	Choose from Memo Wood Finishes on page 7

Notes

For step-by-step specifications and quotes, access our live quote tool online at → [Quotes](#)

Kino

Stool

Designed by Kensaku Oshiro, 2020

Made in the Canada, Assembled in the USA.

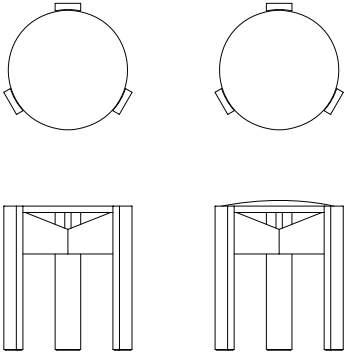

Depth	Width	Height
15.75"	15.75"	17.75 / 18.25"

Core Product	Core Code	List Price
Stool - Ash	KN01-S1-A	641
Stool - Walnut	KN01-S1-W	844

Standard with Core Product

- Glides
- Solid Wood Frame
- Solid Wood Top

Textile Yardage	Seat
Total: .75	.75

List Price by Textile Grade*

	COM / 1	2	3	4	5	6	7	8	9	10	11	12	13	14	15
KN01-S1-A-UTT	906	914	926	933	941	952	965	978	994	1015	1040	1067	1106	1162	1217
KN01-S1-W-UTT	1109	1117	1129	1136	1144	1155	1168	1181	1197	1218	1243	1270	1309	1365	1420

Standard with Core Product

- Non-Marring Glides
- High Resilience Polyurethane Foam

Options and Notes overleaf

Options

	Code	List Price Add
Upholstered Top	UTT	See previous page
Clear Finish (by species)	WCA/WCW	0
Stain Finish - Wood Top	WOA/WWA/WGA/WNP	68

Specifiable Finishes

- Wood Choose from Memo Wood Finishes on Page 7
- Textiles Choose from Camira, Maharam, or Kvadrat textiles on page 74, or contact Memo for assistance with COM fabrics

Notes

For step-by-step specifications and quotes, access our live quote tool online at → [Quotes](#)

Maru Benches

Three Slat Bench - 3/4-Length
Designed by Studio Gorm, 2020
Made in the USA.



Depth Width Height
17.75" 65.5" 17"

Core Product

Three Slat Bench - 3/4-Length - Ash

Core Code

SG03-IND-S3-66W-A

Standard with Core Product

Glides
Solid Ash Wood Frame

Upholstery Configurations

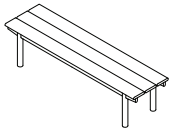

Configuration 1.3-S
(none)

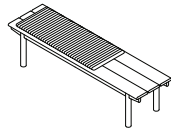

Configuration 2.3-S
-PC2

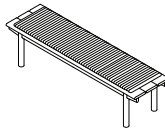

Configuration 3.3-S
-P60D2

Textile Yardage

Pad, Long (60"): 2.75 (each)
Pad, Standard: 1.50 (each)

Upholstery Configurations - List Price by Textile Grade

	Base	COM / 1	2	3	4	5	6	7	8	9	10	11	12	13	14	15
Configuration 1.3-S	2676	n/a	n/a	n/a	n/a	n/a	n/a	n/a	n/a	n/a	n/a	n/a	n/a	n/a	n/a	n/a
Configuration 2.3-S		3314	3331	3353	3368	3385	3406	3431	3458	3490	3532	3581	3637	3715	3826	3937
Configuration 3.3-S		3424	3454	3496	3523	3553	3592	3639	3688	3746	3823	3914	4015	4158	4362	4565

Options and Notes overleaf

Options

Wood Species	Code	List Price Add
Ash	A	0
Walnut	W	1638

Wood Finishes

Clear over Ash/Walnut	WCA/WCW	0
Ash with Stain Finish	WOA/WWA	133

Accessories (see below for visuals)

Table, Round, Ash Veneer	T1	493
Table, Obround, Ash Veneer	T2	607
Power Module/s	PM1/PM2	350/805

Other Options

Veneer Table Top(s), Walnut	VTW	72 (per table)
Forbo Linoleum Table Top(s)	FTT	116 (per table)
Veneer Table Top(s), Ash with Stain	WOA/WWA	60 (per table)

Specifiable Finishes

- Linoleum Choose from Forbo linoleum products on page 7
- Textiles Choose from Maharam, Kvadrat, or Camira textiles on page 74, contact Memo for assistance with COM fabrics
- Wood/Veneer Choose from Memo Wood Finishes on page 7

Notes

For step-by-step specifications and quotes, access our live quote tool online at → [Quotes](#)

Accessories (visuals)

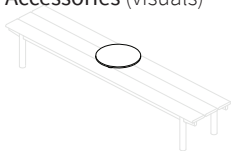

Table, Round
See below for locations

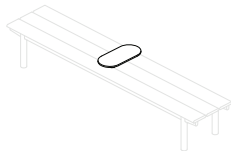

Table, Obround
See below for locations

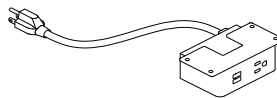

Power Module
1-Power, 2-USB

Table Locations (Round Table shown)

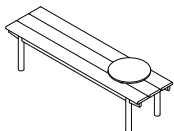

-T1F2
For Configurations 1.3-S

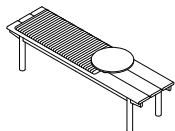

-T1E2
For Configuration 2.3-S

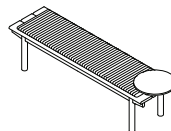

-T1G2
For Configuration 3.3-S

Maru Benches

Three Slat Bench

Designed by Studio Gorm, 2020

Made in the USA.



Depth	Width	Height
17.75"	85.5"	17"

Core Product

Three Slat Bench - Ash

Core Code

SG03-IND-S3-86W-A

Standard with Core Product

Glides

Solid Ash Wood Frame

Upholstery Configurations

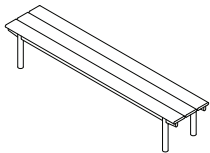

Configuration 1.3
(none)

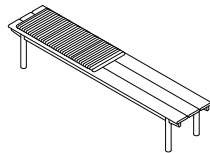

Configuration 2.3
-PC2

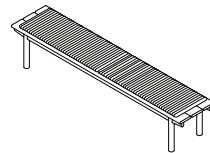

Configuration 3.3
-PC2-PG2

Textile Yardage

Pad: 1.50 (each)

Upholstery Configurations - List Price by Textile Grade

	Base	COM / 1	2	3	4	5	6	7	8	9	10	11	12	13	14	15
Configuration 1.3	3245	n/a	n/a	n/a	n/a	n/a	n/a	n/a	n/a	n/a	n/a	n/a	n/a	n/a	n/a	n/a
Configuration 2.3		3883	3900	3922	3937	3954	3975	4000	4027	4059	4101	4150	4206	4284	4395	4506
Configuration 3.3		4521	4554	4599	4629	4662	4704	4755	4809	4872	4956	5055	5166	5322	5544	5766

Options and Notes overleaf

Options

Wood Species	Code	List Price Add
Ash	A	0
Walnut	W	1708

Wood Finishes

Clear over Ash/Walnut	WCA/WCW	0
Ash with Stain Finish	WOA/WWA	158

Accessories (see below for visuals)

Table, Round, Ash Veneer	T1	493
Table, Obround, Ash Veneer	T2	607
Power Module/s	PM1/PM2	350/805

Other Options

Veneer Table Top(s), Walnut	VTW	72 (per table)
Forbo Linoleum Table Top(s)	FTT	116 (per table)
Veneer Table Top(s), Ash with Stain	WOA/WWA	60 (per table)

Specifiable Finishes

- Linoleum Choose from Forbo linoleum products on page 7
- Textiles Choose from Maharam, Kvadrat or Camira textiles on page 74, contact Memo for assistance with COM fabrics
- Wood/Veneer Choose from Memo Wood Finishes on page 7

Notes

For step-by-step specifications and quotes, access our live quote tool online at → [Quotes](#)

Accessories (visuals)

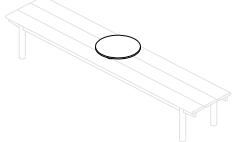

Table, Round
See below for locations

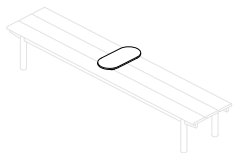

Table, Obround
See below for locations

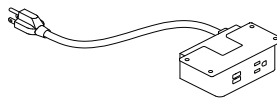

Power Module
1-Power, 2-USB

Table Locations (Round Table shown)

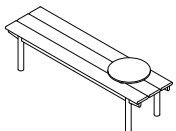

-T1F2
For Configurations 1.3-S

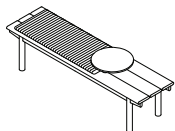

-T1E2
For Configuration 2.3-S

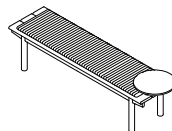

-T1G2
For Configuration 3.3-S

Maru Benches

Five Slat Bench

Designed by Studio Gorm, 2020

Made in the USA.

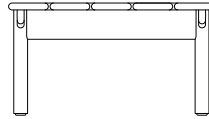

Depth	Width	Height
29.75"	85.5"	17"

Core Product

Five Slat Bench -Ash

Core Code

SG03-IND-S5-86W-A

Standard with Core Product

Glides

Solid Ash Wood Frame

Upholstery Configurations

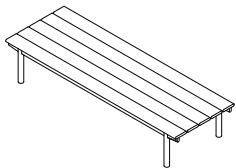

Configuration 1.5
(none)

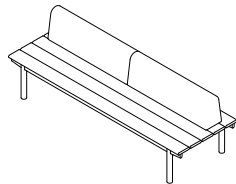

Configuration 2.5
-BC2-BG2

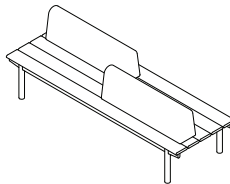

Configuration 3.5
-BC2-BG4

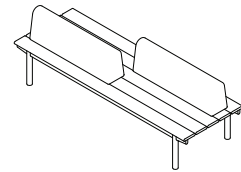

Configuration 4.5
-BC4-BG2

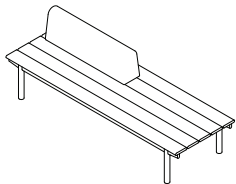

Configuration 5.5
-BC2

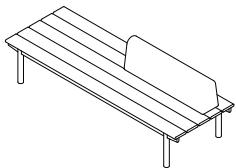

Configuration 6.5
-BG2

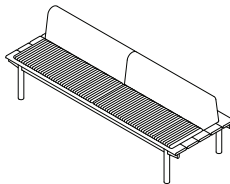

Configuration 7.5
-BC2-BG2-PC4-PG4

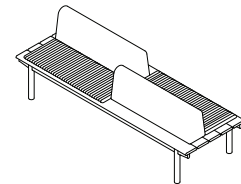

Configuration 8.5
-BC2-BG4-PC4-PG2

More Configurations, Pricing, Options, and Notes overleaf

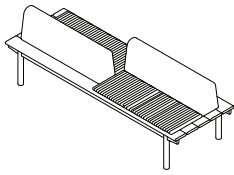

Configuration 9.5
-BG4-BG2-PC2-PG4

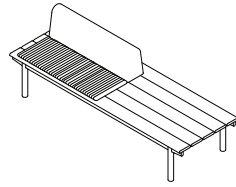

Configuration 10.5
-BC2-PC4

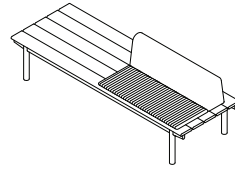

Configuration 11.5
-BG2-PG4

Textile Yardage

Bolster: 1.25 (each)
Pad: 2.75 (each)

Upholstery Configurations - List Price by Textile Grade*

	Base	COM / 1	2	3	4	5	6	7	8	9	10	11	12	13	14	15
Configuration 1.5	4541	n/a	n/a	n/a	n/a	n/a	n/a	n/a	n/a	n/a	n/a	n/a	n/a	n/a	n/a	n/a
Configuration 2.5		5823	5851	5888	5913	5941	5976	6018	6063	6116	6186	6268	6361	6491	6676	6861
Configuration 3.5		5823	5851	5888	5913	5941	5976	6018	6063	6116	6186	6268	6361	6491	6676	6861
Configuration 4.5		5823	5851	5888	5913	5941	5976	6018	6063	6116	6186	6268	6361	6491	6676	6861
Configuration 5.5		5182	5196	5215	5227	5241	5258	5280	5302	5328	5363	5405	5451	5516	5608	5701
Configuration 6.5		5182	5196	5215	5227	5241	5258	5280	5302	5328	5363	5405	5451	5516	5608	5701
Configuration 7.5		7099	7160	7242	7297	7358	7435	7528	7627	7743	7897	8078	8282	8568	8975	9382
Configuration 8.5		7099	7160	7242	7297	7358	7435	7528	7627	7743	7897	8078	8282	8568	8975	9382
Configuration 9.5		7099	7160	7242	7297	7358	7435	7528	7627	7743	7897	8078	8282	8568	8975	9382
Configuration 10.5		5820	5850	5892	5919	5949	5988	6035	6084	6142	6219	6310	6411	6554	6758	6961
Configuration 11.5		5820	5850	5892	5919	5949	5988	6035	6084	6142	6219	6310	6411	6554	6758	6961

*Pricing assumes single textile selection for pads and bolsters. For multiple textiles please visit → Quotes

Options

Wood Species	Code	List Price Add
Ash	A	0
Walnut	W	2274

Wood Finishes	Code	List Price Add
Clear over Ash/Walnut	WCA/WCW	0
Ash with Stain Finish	WOA/WWA	300

Accessories (see below for visuals)	Code	List Price Add
Dowel Partition, Ash	SCR1A	3053
Dowel Partition, Ash with Stain Finish	WOA/WWA	600
Table, Round, Ash Veneer	T1	493
Table, Obround, Ash Veneer	T2	607
Power Module/s	PM1/PM2	350/805

More Options, Visuals, and Notes overleaf

Other Options

Veneer Table Top(s), Walnut	VTW	72 (per table)
Forbo Linoleum Table Top(s)	FTT	116 (per table)
Veneer Table Top(s), Ash with Stain	WOA/WWA	60 (per table)

Specifiable Finishes

Linoleum	Choose from Forbo linoleum products on page 7
Textiles	Choose from Maharam, Kvadrat, or Camira textiles on page 74, contact Memo for assistance with COM fabrics
Wood/Veneer	Choose from Memo Wood Finishes on page 7

Notes

For step-by-step specifications and quotes, access our live quote tool online at → [Quotes](#)

Accessories (visuals)

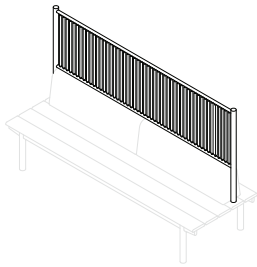

Dowel Partition
Only for Configurations 2.5, 7.5

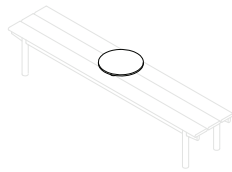

Table, Round
See below for locations

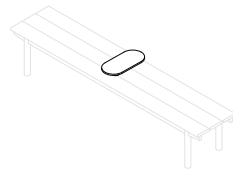

Table, Obround
See below for locations

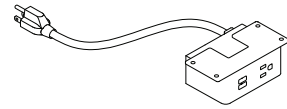

Power Module
1-Power, 2-USB

Table Locations (Round Table shown)

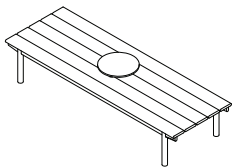

-T1E3
For Configuration 1.5

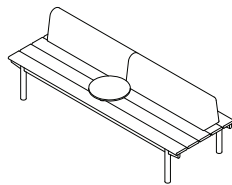

-T1E4
For Configurations 2.5, 5.5, 6.5, 7.5, 10.5, 11.5

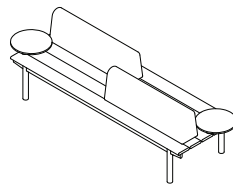

-T1A4-T1I2
For Configuration 3.5, 8.5

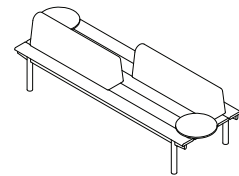

-T1A2-T1I4
For Configuration 4.5, 9.5

Maru Benches

Seven Slat Bench

Designed by Studio Gorm, 2020

Made in the USA.

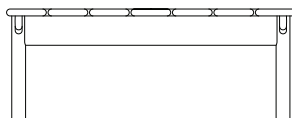

Depth	Width	Height
41.75"	85.5"	17"

Core Product

Seven Slat Bench - Ash

Core Code

SG03-IND-S7-86W-A

Standard with Core Product

Glides

Solid Ash Wood Frame

Upholstery Configurations

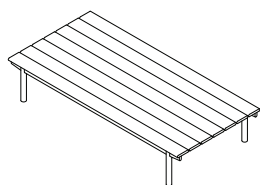

Configuration 1.7
(none)

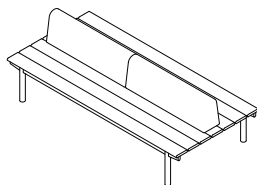

Configuration 2.7
-BC4-BG4

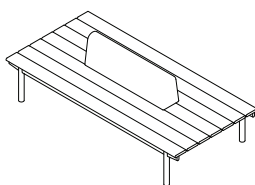

Configuration 3.7
-BE4

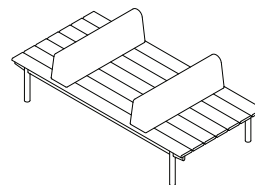

Configuration 4.7
-BC4R-BG4R

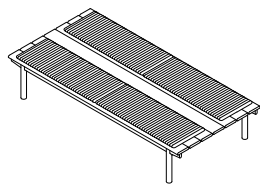

Configuration 5.7
-PC2-PC6-PG2-PG6

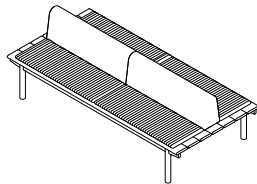

Configuration 6.7
-BC4-BG4-PC2-PC6-PG2-PG6

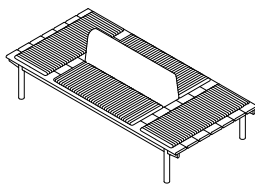

Configuration 7.7
-BE4-PB4R-PE2-PE6-PH4R

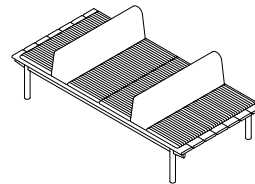

Configuration 8.7
-BC4R-BG4R-PB4R-PD4R-PF4R-PH4R

Pricing, Options, and Notes overleaf

Textile Yardage

Bolster:	1.25	(each)
Pad:	2.75	(each)

Upholstery Configurations - List Price by Textile Grade*

	Base COM /	1	2	3	4	5	6	7	8	9	10	11	12	13	14	15
Configuration 1.7	6142	n/a	n/a	n/a	n/a	n/a	n/a	n/a	n/a	n/a	n/a	n/a	n/a	n/a	n/a	n/a
Configuration 2.7		7424	7452	7489	7514	7542	7577	7619	7664	7717	7787	7869	7962	8092	8277	8462
Configuration 3.7		6783	6797	6816	6828	6842	6859	6881	6903	6929	6964	7006	7052	7117	7209	7302
Configuration 4.7		7424	7452	7489	7514	7542	7577	7619	7664	7717	7787	7869	7962	8092	8277	8462
Configuration 5.7		8694	8760	8850	8910	8976	9060	9162	9270	9396	9564	9762	9984	10296	10740	11184
Configuration 6.7		9976	10070	10197	10282	10376	10495	10639	10792	10971	11209	11489	11804	12246	12875	13504
Configuration 7.7		9335	9415	9524	9596	9676	9777	9901	10031	10183	10386	10626	10894	11271	11807	12344
Configuration 8.7		9976	10070	10197	10282	10376	10495	10639	10792	10971	11209	11489	11804	12246	12875	13504

*Pricing assumes single textile selection for pads and bolsters. For multiple textiles please visit → Quotes

Options

Wood Species	Code	List Price Add
Ash	A	0
Walnut	W	3278

Wood Finishes

Clear over Ash/Walnut	WCA/WCW	0
Ash with Stain Finish	WOA/WWA	380

Accessories (see following page for visuals)

Dowel Partition, Ash	SCR1A	3053
Dowel Partition, Ash with Stain Finish	WOA/WWA	600
Table, Round, Ash Veneer	T1	493
Table, Obround, Ash Veneer	T2	607
Power Module/s	PM1/PM2	305/805

Other Options

	Code	List Price Add
Multiple Textiles (bolster/pad)	TA	140
Veneer Table Top(s), Walnut	VTW	72 (per table)
Veneer Table Top(s), Ash with Stain Finish	WOA/WWA	60 (per table)
Forbo Linoleum Table Top(s)	FTT	116 (per table)

More Options, Visuals, and Notes overleaf

Specifiable Finishes

Linoleum

Choose from Forbo linoleum products on page 7

Textiles

Choose from Maharam, Kvadrat, or Camira textiles on page 74, contact Memo for assistance with COM fabrics

Wood/Veneer

Choose from Memo Wood Finishes on page 7

Notes

For step-by-step specifications and quotes, access our live quote tool online at → [Quotes](#)

Accessories (visuals)

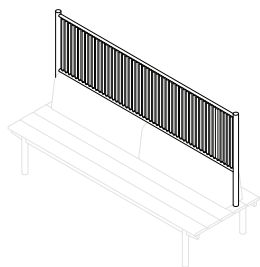

Dowel Partition

Only for Configurations 2.7, 6.7

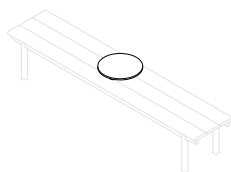

Table, Round

See below for locations

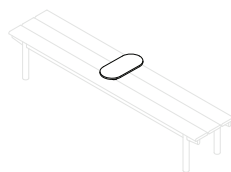

Table, Obround

See below for locations

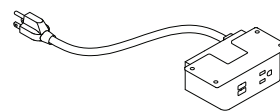

Power Module

1-Power, 2-USB

Table Locations (Round Table shown)

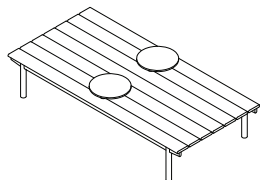

-T1E2-T1E6

For Configurations 1.7, 5.7

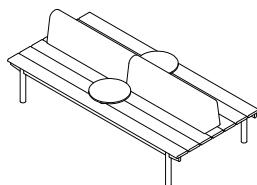

-T1E2-T1E6

For Configurations 2.7, 6.7

Orca

Vertical Screen

Designed by Alex Brokamp , 2020

Made in the USA.

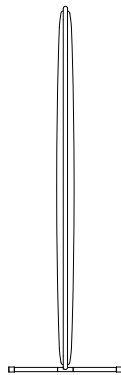
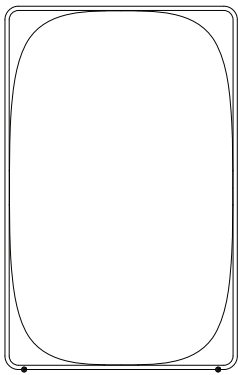
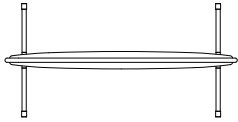

Depth	Width	Height
20"	40.9"	64.3"

Core Product

Vertical Screen

Core Code

AB01-V

List Price by Textile Grade*

	COM / 1	2	3	4	5	6	7	8	9	10	11	12	13	14	15
AB01-V	2164	2208	2268	2308	2352	2408	2476	2548	2632	2744	2876	3024	3232	3528	3824

*Pricing assumes a single textile selection for both sides. For multiple textiles please visit → Quotes

Textiles

AB01 screens are available in select textiles that meet ASTM-E84 Class A Unadhered Testing and are suitable for panel applications.

Choose From:

Camira Quest (Group 3)

Kvadrat Remix (Group 8)

Maharam Murmur (Group 5)

Camira Blaze (Group 7)

Kvadrat Melange Nap (Group 10)

Maharam Flock (Group 7)

Textile Yardage

Total: 4.0

Side A

2.0

Side B

2.0

Standard with Core Product

Steel Frame with Black Powdercoat

Upholstered Field

Non-marring glides

Options

Component	Code	List Price Add
Multiple Textiles (Side A / Side B)	TA	140

Specifiable Finishes

Textiles Choose from Camira, Maharam, or Kvadrat textiles on previous page

Notes

Multiple Textile option allows for separate textiles on each side
For step-by-step specifications and quotes, access our live quote tool online at → [Quotes](#)

Orca

Horizontal Screen

Designed by Alex Brokamp , 2020

Made in the USA.

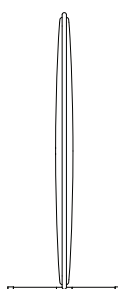
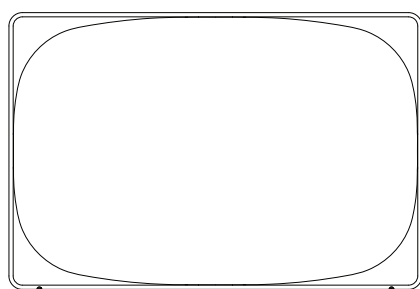
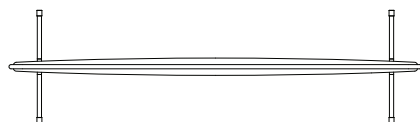

Depth	Width	Height
20"	72.9"	49.3"

Core Product

Horizontal Screen

Core Code

AB01-H

List Price by Textile Grade*

	COM / 1	2	3	4	5	6	7	8	9	10	11	12	13	14	15
AB01-H	2409	2459	2526	2571	2621	2684	2760	2841	2936	3062	3210	3377	3611	3944	4277

Textiles

AB01 screens are available in select textiles that meet ASTM-E84 Class A Unadhered Testing and are suitable for panel applications.

Choose From:

Camira Quest (Group 3)

Kvadrat Remix (Group 8)

Maharam Murmur (Group 5)

Camira Blaze (Group 7)

Kvadrat Melange Nap (Group 10)

Maharam Flock (Group 7)

*Pricing assumes a single textile selection for both sides. For multiple textiles please visit → Quotes

Textile Yardage	Side A	Side B
Total: 4.5	2.25	2.25

Standard with Core Product

Steel Frame with Black Powdercoat

Upholstered Field

Non-marring glides

Options

Component	Code	List Price Add
Multiple Textiles (Side A / Side B)	TA	140

Specifiable Finishes

Textiles Choose from Camira, Maharam, or Kvadrat textiles on previous page

Notes

Multiple Textile option allows for separate textiles on each side
For step-by-step specifications and quotes, access our live quote tool online at → [Quotes](#)

Penna

Lounge

Designed by Studio Gorm, 2019

Made in the USA.

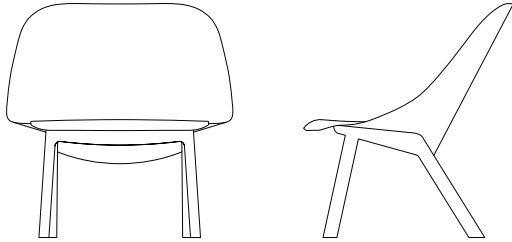

Depth	Width	Height
32"	25.5"	30"

Core Product

Lounge - Ash
Lounge - Walnut

Core Code

SG01-01-A
SG01-01-W

Textile Yardage

	Seat	Back	Arms
Total: 3	.75	2.25	n/a

List Price by Textile Grade*

	COM / 1	2	3	4	5	6	7	8	9	10	11	12	13	14	15
SG01-01-A	2747	2780	2825	2855	2888	2930	2981	3035	3098	3182	3281	3392	3548	3770	3992
SG01-01-W	3442	3475	3520	3550	3583	3625	3676	3730	3793	3877	3976	4087	4243	4465	4687

*Pricing assumes a single textile selection for seat and back. For multiple textiles please visit → Quotes

Standard with Core Product

Non-Marring Glides
High Resilience Polyurethane Foam

Options

Component	Code	List Price Add
Multiple Textiles (Seat/Back)	TA	140
Stain Finish on Base	WOA/WWA	88

Specifiable Finishes

Textiles Choose from Camira, Maharam, or Kvadrat textiles on page 74, or contact Memo for assistance with COM fabrics
Wood Choose from Memo Wood Finishes on page 7

Notes

Multiple Textile option allows for separate seat and back textiles
For step-by-step specifications and quotes, access our live quote tool online at → Quotes

Penna

Large Round Table

Designed by Studio Gorm, 2019

Made in the USA.

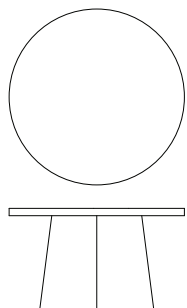

Depth	Width	Height
30"	30"	17.5"

Core Product	Core Code	List Price
Large Round Table - Ash	SG01-T1-A	2213
Large Round Table - Walnut	SG01-T1-W	2385

Standard with Core Product

- Glides
- Forbo Linoleum Top
- Solid Wood Edge Band (finish to match base)
- Wood Veneer Base

Options

Component	Code	List Price Add
Forbo Linoleum Top	FTT	0
Wood Veneer Top (Ash)	VTA	161
Wood Veneer Top (Walnut)	VTW	281
Ash with Stain Finish	WOA/WWA/WGA/WNP	109
Power Module (2-power, 2-USB)	PM1	343

Specifiable Finishes

- Linoleum Choose from Forbo linoleum products on page 7
- Wood Choose from Memo Wood Finishes on page 7

Notes

For step-by-step specifications and quotes, access our live quote tool online at → [Quotes](#)

Penna

Obround Table

Designed by Studio Gorm, 2019

Made in the USA.

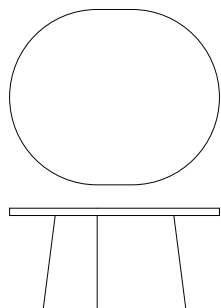

Depth	Width	Height
30"	36"	17.5"

Core Product	Core Code	List Price
Obround Table - Ash	SG01-T2-A	2343
Obround Table - Walnut	SG01-T2-W	2557

Standard with Core Product

- Glides
- Forbo Linoleum Top
- Solid Wood Edge Band (finish to match base)
- Wood Veneer Base

Options

Component	Code	List Price Add
Forbo Linoleum Top	FTT	0
Wood Veneer Top (Ash)	VTA	146
Wood Veneer Top (Walnut)	VTW	272
Ash with Stain Finish	WOA/WWA/WGA/WNP	116
Power Module (2-power, 2-USB)	PM1	343

Specifiable Finishes

- Linoleum Choose from Forbo linoleum products on page 7
- Wood Choose from Memo Wood Finishes on page 7

Notes

For step-by-step specifications and quotes, access our live quote tool online at → [Quotes](#)

Penna

Small Round Table

Designed by Studio Gorm, 2019

Made in the USA.

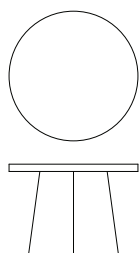

Depth	Width	Height
22.5"	22.5"	16"

Core Product	Core Code	List Price
Small Round Table - Ash	SG01-T3-A	1944
Small Round Table - Walnut	SG01-T3-W	2132

Standard with Core Product

Glides

Forbo Linoleum Top

Solid Wood Edge Band (finish to match base)

Wood Veneer Base

Options

Component	Code	List Price Add
Forbo Linoleum Top	FTT	0
Wood Veneer Top (Ash)	VTA	123
Wood Veneer Top (Walnut)	VTW	192
Ash with Stain Finish	WOA/WWA/WGA/WNP	106
Power Module (2-power, 2-USB)	PM1	343

Specifiable Finishes

Linoleum Choose from Forbo linoleum products on page 7

Wood Choose from Memo Wood Finishes on page 7

Notes

For step-by-step specifications and quotes, access our live quote tool online at → [Quotes](#)

Penna

Bar Table

Designed by Studio Gorm, 2020

Made in the USA.

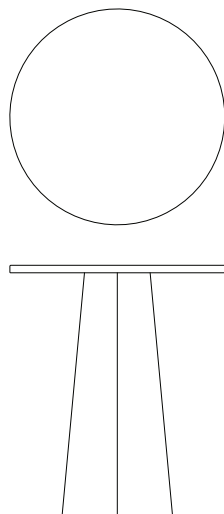

Depth	Width	Height
36"	36"	42"

Core Product	Core Code	List Price
Bar Table - Ash	SG01-T8-36D-A	3586
Bar Table - Walnut	SG01-T8-36D-W	3816

Standard with Core Product

- Glides
- Forbo Linoleum Top
- Solid Wood Edge Band (finish to match base)
- Wood Veneer Base

Options

Component	Code	List Price Add
Forbo Linoleum Top	FTT	0
Wood Veneer Top (Ash)	VTA	205
Wood Veneer Top (Walnut)	VTW	256
Ash with Stain Finish	WOA/WWA/WGA/WNP	115
Power Module (2-power, 2-USB)	PM1	343

Specifiable Finishes

- Linoleum Choose from Forbo linoleum products on page 7
- Wood Choose from Memo Wood Finishes on page 7

Notes

Bases ship with sandbags in certain models, for ballast

For step-by-step specifications and quotes, access our live quote tool online at → [Quotes](#)

Penna

Café Table

Designed by Studio Gorm, 2020

Made in the USA.

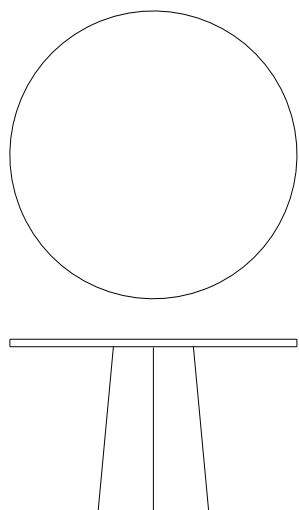

Depth	Width	Height
48"	48"	29"

Core Product	Core Code	List Price
Café Table - Ash	SG01-T6-48D-A	3752
Café Table - Walnut	SG01-T6-48D-W	3989

Standard with Core Product

- Glides
- Forbo Linoleum Top
- Solid Wood Edge Band (finish to match base)
- Wood Veneer Base

Options

Component	Code	List Price Add
Forbo Linoleum Top	FTT	0
Wood Veneer Top (Ash)	VTA	214
Wood Veneer Top (Walnut)	VTW	281
Ash with Stain Finish	WOA/WWA/WGA/WNP	126
Power Module (2-power, 2-USB)	PM1	343

Specifiable Finishes

- Linoleum Choose from Forbo linoleum products on page 7
- Wood Choose from Memo Wood Finishes on page 7

Notes

Bases ship with sandbags in certain models, for ballast

For step-by-step specifications and quotes, access our live quote tool online at → [Quotes](#)

Penna

Meeting Table

Designed by Studio Gorm, 2020

Made in the USA.

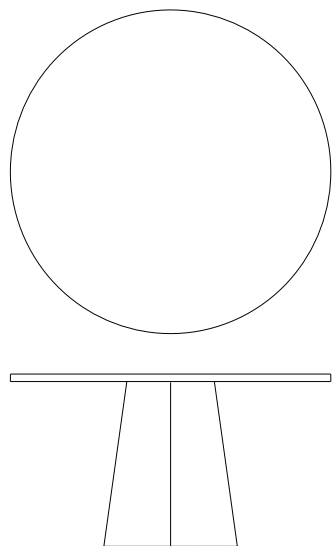

Depth	Width	Height
54"	54"	29"

Core Product	Core Code	List Price
Meeting Table - Ash	SG01-T7-54D-A	3811
Meeting Table - Walnut	SG01-T7-54D-W	4059

Standard with Core Product

- Glides
- Forbo Linoleum Top
- Solid Wood Edge Band (finish to match base)
- Wood Veneer Base

Options

Component	Code	List Price Add
Forbo Linoleum Top	FTT	0
Wood Veneer Top (Ash)	VTA	233
Wood Veneer Top (Walnut)	VTW	303
Ash with Stain Finish	WOA/WWA/WGA/WNP	130
Power Module (2-power, 2-USB)	PM1	343

Specifiable Finishes

- Linoleum Choose from Forbo linoleum products on page 7
- Wood Choose from Memo Wood Finishes on page 7

Notes

Bases ship with sandbags in certain models, for ballast

For step-by-step specifications and quotes, access our live quote tool online at → [Quotes](#)

Penna

Height Adjustable Café Table
Designed by Studio Gorm, 2020
Made in the USA.

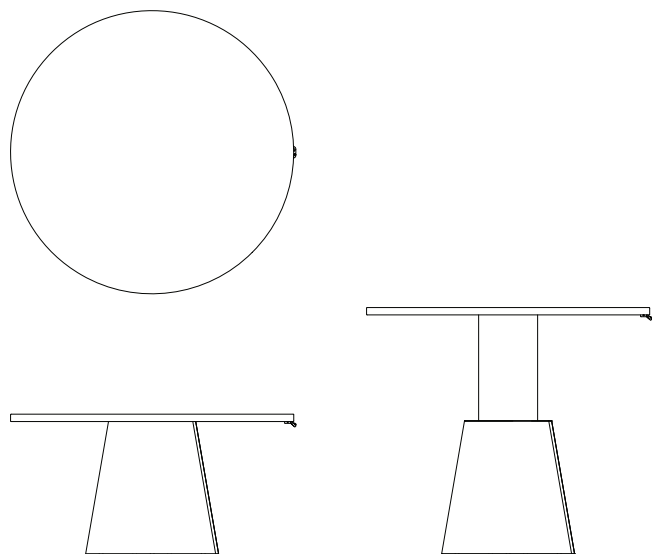

Depth	Width	Height
48"	48"	24" - 42"

Core Product	Core Code	List Price
Café Table - Ash	SG01-T6-HAT-48D-A-MA	7596
Café Table - Walnut	SG01-T6-HAT-48D-W-MA	7877

Standard with Core Product

- Glides
- Forbo Linoleum Top
- Solid Wood Edge Band (finish to match base)
- Wood Veneer Base

Options

Component	Code	List Price Add
Forbo Linoleum Top	FTT	0
Wood Veneer Top (Ash)	VTA	214
Wood Veneer Top (Walnut)	VTW	281
Ash with Stain Finish	WOA/WWA/WGA/WNP	199
Adjustable Height Column Shroud	PEW/PCY/PFG/POB/PBO/PSG/PDP	0

Specifiable Finishes and Notes overleaf

Specifiable Finishes

Linoleum	Choose from Forbo linoleum products on page 7
Wood	Choose from Memo Wood Finishes on page 7
Painted Wood	PEW/PCY/PFG/POB/PBO/PSG/PDP

Notes

Bases ship with sandbags in certain models, for ballast

For step-by-step specifications and quotes, access our live quote tool online at → [Quotes](#)

Penna

Height Adjustable Meeting Table

Designed by Studio Gorm, 2020

Made in the USA.

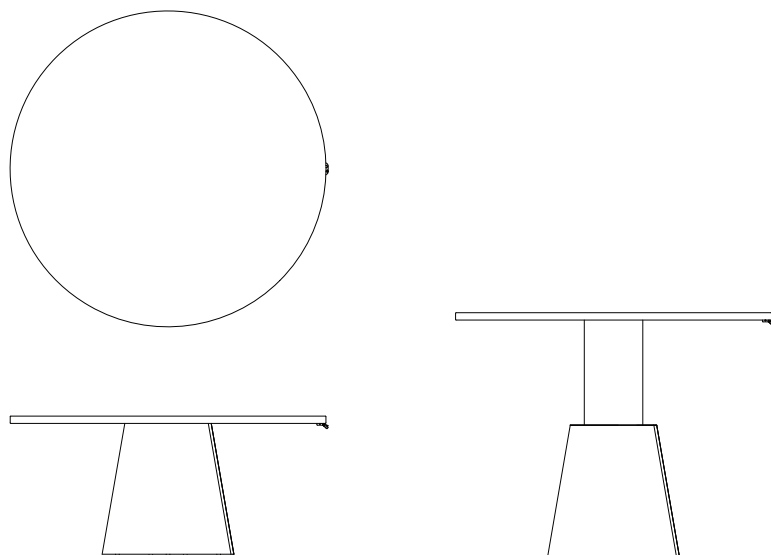

Depth	Width	Height
54"	54"	24" - 42"

Core Product

Meeting Table - Ash
Meeting Table - Walnut

Core Code

SG01-T7-HAT-54D-A-MA
SG01-T7-HAT-54D-W-MA

List Price

7659
7945

Standard with Core Product

- Glides
- Forbo Linoleum Top
- Solid Wood Edge Band (finish to match base)
- Wood Veneer Base

Options

Component	Code	List Price Add
Forbo Linoleum Top	FTT	0
Wood Veneer Top (Ash)	VTA	233
Wood Veneer Top (Walnut)	VTW	333
Ash with Stain Finish	WOA/WWA/WGA/WNP	209
Adjustable Height Column Shroud	PEW/PCY/PFG/POB/PBO/PSG/PDP	0

Specifiable Finishes and Notes overleaf

Specifiable Finishes

Linoleum	Choose from Forbo linoleum products on page 7
Wood	Choose from Memo Wood Finishes on page 7
Painted Wood	PEW/PCY/PFG/POB/PBO/PSG/PDP

Notes

Bases ship with sandbags in certain models, for ballast

For step-by-step specifications and quotes, access our live quote tool online at → [Quotes](#)

Penna

Height Adjustable Café Table
Designed by Studio Gorm, 2020
Made in the USA.

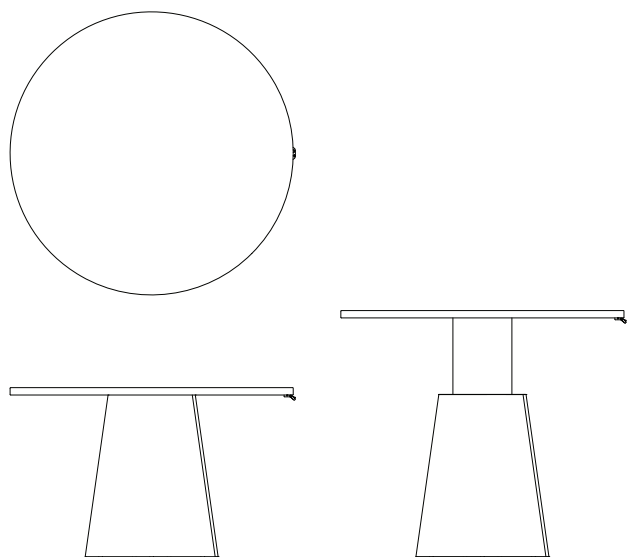

Depth	Width	Height
48"	48"	29" - 42"

Core Product	Core Code	List Price
Café Table - Ash	SG01-T6-HAT-48D-A-MB	7596
Café Table - Walnut	SG01-T6-HAT-48D-W-MB	7877

Standard with Core Product

- Glides
- Forbo Linoleum Top
- Solid Wood Edge Band (finish to match base)
- Wood Veneer Base

Options

Component	Code	List Price Add
Forbo Linoleum Top	FTT	0
Wood Veneer Top (Ash)	VTA	214
Wood Veneer Top (Walnut)	VTW	281
Ash with Stain Finish	WOA/WWA/WGA/WNP	199
Adjustable Height Column Shroud	PEW/PCY/PFG/POB/PBO/PSG/PDP	0

Specifiable Finishes and Notes overleaf

Specifiable Finishes

Linoleum	Choose from Forbo linoleum products on page 7
Wood	Choose from Memo Wood Finishes on page 7
Painted Wood	PEW/PCY/PFG/POB/PBO/PSG/PDP

Notes

Bases ship with sandbags in certain models, for ballast

For step-by-step specifications and quotes, access our live quote tool online at → [Quotes](#)

Penna

Height Adjustable Meeting Table

Designed by Studio Gorm, 2020

Made in the USA.

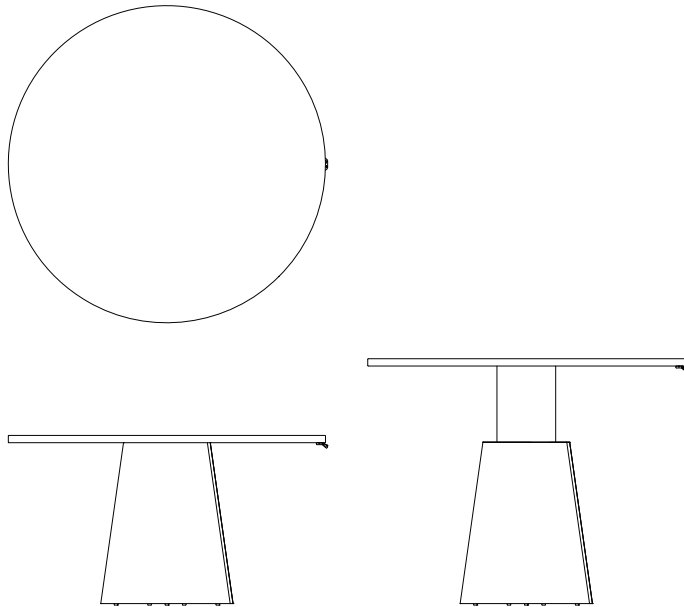

Depth	Width	Height
54"	54"	29" - 42"

Core Product

Meeting Table - Ash
Meeting Table - Walnut

Core Code

SG01-T7-HAT-54D-A-MB
SG01-T7-HAT-54D-W-MB

List Price

7659
7945

Standard with Core Product

- Glides
- Forbo Linoleum Top
- Solid Wood Edge Band (finish to match base)
- Wood Veneer Base

Options

Component	Code	List Price Add
Forbo Linoleum Top	FTT	0
Wood Veneer Top (Ash)	VTA	233
Wood Veneer Top (Walnut)	VTW	333
Ash with Stain Finish	WOA/WWA/WGA/WNP	209
Adjustable Height Column Shroud	PEW/PCY/PFG/POB/PBO/PSG/PDP	0

Specifiable Finishes and Notes overleaf

Specifiable Finishes

Linoleum	Choose from Forbo linoleum products on page 7
Wood	Choose from Memo Wood Finishes on page 7
Painted Wood	PEW/PCY/PFG/POB/PBO/PSG/PDP

Notes

Bases ship with sandbags in certain models, for ballast

For step-by-step specifications and quotes, access our live quote tool online at → [Quotes](#)

Prose Seating

Side Chair with Arms

Designed by Memo Studio, 2017

Made in the USA.

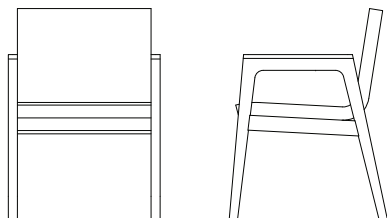

Depth	Width	Height
24"	23"	33"

Core Product

Side Chair with Arms - Ash

Core Code

GC01-10-A

Textile Yardage

Total: 1.50

Seat Back Arms

n/a n/a n/a

List Price by Textile Grade

	COM / 1	2	3	4	5	6	7	8	9	10	11	12	13	14	15
GC01-10-A	1839	1856	1878	1893	1910	1931	1956	1983	2015	2057	2109	2162	2240	2351	2462

Standard with Core Product

Glides

High Resilience Polyurethane Foam

Solid Wood Arm Caps

Options and Notes overleaf

Options

Component	Code	List Price Add							
Ash with Stain Finish	WOA/WWA	140							
Solid Surface Arm Caps	by Grade (right)	CA1	CA2	CA3	CA4	CA5	CA6	CA7	
		277	337	337	474	474	553	553	
Removable Covers	RC	149							
Moisture Barrier	MB	222							

Specifiable Finishes

- Solid Surface Choose from Corian solid surface products on page 88
- Textiles Choose from Camira, Kvadrat, or Maharam textiles on page 74, or contact Memo for assistance with COM fabrics
- Wood Choose from Memo Wood Finishes on page 7

Notes

Due to its continuous seat and back, multiple fabric configurations are not supported on the Prose Side Chair with Arms
For step-by-step specifications and quotes, access our live quote tool online at memofurniture.com/quotes

Prose Seating

Plus Chair

Designed by Memo Studio, 2017

Made in the USA.

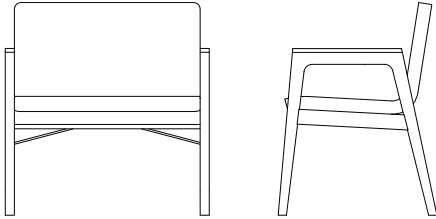

Depth	Width	Height
24"	30.75"	33"

Core Product

Plus Chair - Ash

Core Code

GC01-15-A

Textile Yardage

Total: 2.00

Seat	Back	Arms
n/a	n/a	n/a

List Price by Textile Grade

	COM / 1	2	3	4	5	6	7	8	9	10	11	12	13	14	15
GC01-15-A	2283	2305	2335	2355	2377	2405	2439	2475	2517	2573	2643	2713	2817	2965	3113

Standard with Core Product

Glides

High Resilience Polyurethane Foam

Solid Wood Arm Caps

Options and Notes overleaf

Options

Component	Code	List Price Add							
Ash with Stain Finish	WOA/WWA	140							
Solid Surface Arm Caps	by Grade (right)	CA1 277	CA2 337	CA3 337	CA4 474	CA5 474	CA6 553	CA7 553	
Removable Covers	RC	179							
Moisture Barrier	MB	222							

Specifiable Finishes

- Solid Surface Choose from Corian solid surface products on page 88
- Textiles Choose from Camira, Kvadrat, or Maharam textiles on page 74, or contact Memo for assistance with COM fabrics
- Wood Choose from Memo Wood Finishes on page 7

Notes

Due to its continuous seat and back, multiple fabric configurations are not supported on the Prose Plus Chair
For step-by-step specifications and quotes, access our live quote tool online at memofurniture.com/quotes

Prose Seating

Settee

Designed by Memo Studio, 2017

Made in the USA.

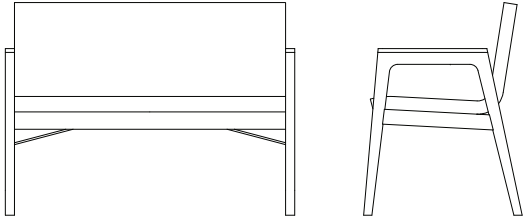

Depth	Width	Height
24"	43.75"	33"

Core Product

Settee - Ash

Core Code

GC01-22-A

Textile Yardage

Total: 2.50

Seat	Back	Arms
n/a	n/a	n/a

List Price by Textile Grade

	COM / 1	2	3	4	5	6	7	8	9	10	11	12	13	14	15
GC01-22-A	3054	3082	3119	3144	3172	3207	3249	3294	3347	3417	3504	3592	3722	3907	4092

Standard with Core Product

Glides

High Resilience Polyurethane Foam

Solid Wood Arm Caps

Options and Notes overleaf

Options

Component	Code	List Price Add							
Ash with Stain Finish	WOA/WWA	140							
Solid Surface Arm Caps	by Grade (right)	CA1	CA2	CA3	CA4	CA5	CA6	CA7	
		277	337	337	474	474	553	553	
Removable Covers	RC	197							
Moisture Barrier	MB	244							

Specifiable Finishes

- Solid Surface Choose from Corian solid surface products on page 88
- Textiles Choose from Camira, Kvadrat, or Maharam textiles on page 74, or contact Memo for assistance with COM fabrics
- Wood Choose from Memo Wood Finishes on page 7

Notes

Due to its continuous seat and back, multiple fabric configurations are not supported on the Prose Settee
For step-by-step specifications and quotes, access our live quote tool online at memofurniture.com/quotes

Prose Seating

Lounge

Designed by Memo Studio, 2017

Made in the USA.

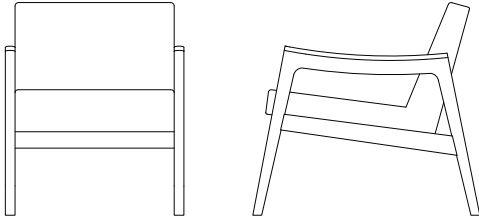

Depth	Width	Height
32"	25.5"	30"

Core Product

Lounge - Ash

Core Code

GC01-01-A

Textile Yardage

Total: 2.00

Seat	Back	Arms
1.00	1.00	n/a

List Price by Textile Grade

	COM / 1	2	3	4	5	6	7	8	9	10	11	12	13	14	15
GC01-01-A	2739	2761	2791	2811	2833	2861	2895	2931	2973	3029	3099	3169	3273	3421	3569

Standard with Core Product

Glides

High Resilience Polyurethane Foam

Solid Wood Arm Caps

Options and Notes overleaf

Options

Component	Code	List Price Add							
Ash with Stained Finish	WOA/WWA	140							
Solid Surface Arm Caps	by Grade (right)	CA1	CA2	CA3	CA4	CA5	CA6	CA7	
		291	354	354	499	499	582	582	
Removable Covers	RC	179							
Moisture Barrier	MB	222							
Multiple Textiles (Seat/Back)	TA	140							

Specifiable Finishes

- Solid Surface Choose from Corian solid surface products on page 88
- Textiles Choose from Camira, Kvadrat, or Maharam textiles on page 74, or contact Memo for assistance with COM fabrics
- Wood Choose from Memo Wood Finishes on page 7

Notes

Available in custom widths per engineering and quote approval
 Multiple fabric option allows for separate seat and back textiles
 For step-by-step specifications and quotes, access our live quote tool online at memofurniture.com/quotes

Prose Seating

Loveseat

Designed by Memo Studio, 2017

Made in the USA.

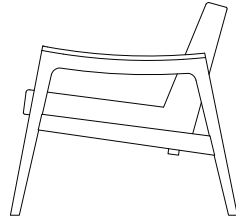
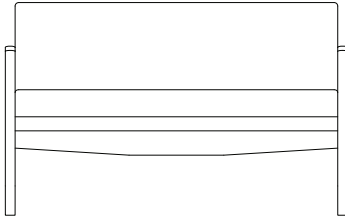

Depth	Width	Height
32"	48"	30"

Core Product

Loveseat - Ash

Core Code

GC01-02-A

Textile Yardage

Total: 4.00

Seat	Back	Arms
2.00	2.00	n/a

List Price by Textile Grade

	COM / 1	2	3	4	5	6	7	8	9	10	11	12	13	14	15
GC01-02-A	3430	3474	3534	3574	3618	3674	3742	3814	3898	4010	4150	4290	4498	4794	5090

Standard with Core Product

Glides

High Resilience Polyurethane Foam

Solid Wood Arm Caps

Options and Notes overleaf

Options

Component	Code	List Price Add						
Ash with Stain Finish	WOA/WWA	140						
Solid Surface Arm Caps	by Grade (right)	CA1 291	CA2 354	CA3 354	CA4 499	CA5 499	CA6 582	CA7 582
Removable Covers	RC	219						
Moisture Barrier	MB	252						
Multiple Textiles (Seat/Back)	TA	140						

Specifiable Finishes

- Solid Surface Choose from Corian solid surface products on page 88
- Textiles Choose from Camira, Kvadrat, or Maharam textiles on page 74, or contact Memo for assistance with COM fabrics
- Wood Choose from Memo Wood Finishes on page 7

Notes

Available in custom widths per engineering and quote approval
 Multiple fabric option allows for separate seat and back textiles
 For step-by-step specifications and quotes, access our live quote tool online at memofurniture.com/quotes

Rolo

Lounge

Designed by Studio Tolvanen, 2021

Made in the USA.

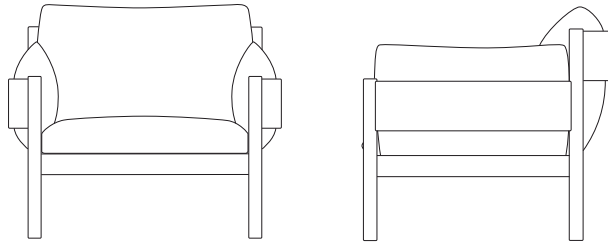

Depth **Width** **Height**
32" 36" 31"

Core Product

Lounge - Ash
Lounge - Walnut

Core Code

ST01-01-A
ST01-01-W

Textile Yardage

Total: 5.25

List Price by Textile Grade*

	COM / 1	2	3	4	5	6	7	8	9	10	11	12	13	14	15
ST01-01-A	3976	4034	4113	4165	4223	4296	4386	4480	4590	4737	4911	5105	5378	5766	6155
ST01-01-W	5051	5109	5188	5240	5298	5371	5461	5555	5665	5812	5986	6180	6453	6841	7230

*Pricing assumes non-railroaded textiles. For railroaded pricing please contact us at info@memofurniture.com

Standard with Core Product

Non-Marring Glides
High Resilience Polyurethane Foam

Options

	Code	List Price Add
Clear Finish (by species)	WCA/WCW	0
Ash with Stain Finish	WOA/WWA	123

Specifiable Finishes

Textiles Choose from Camira, Maharam, or Kvadrat textiles on page 74, or contact Memo for assistance with COM fabrics
Wood Choose from Memo Wood Finishes on page 7

Notes

For step-by-step specifications and quotes, access our live quote tool online at → [Quotes](#)

Rolo

Loveseat

Designed by Studio Tolvanen, 2021

Made in the USA.

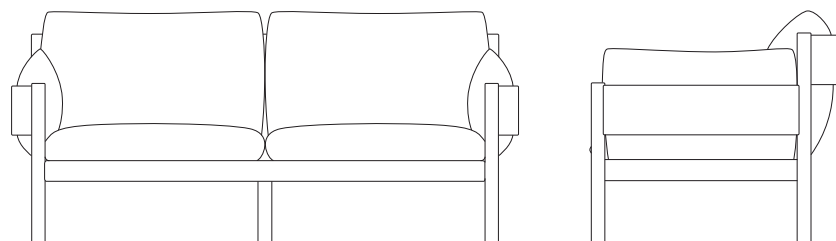

Depth	Width	Height
32"	65"	31"

Core Product

Loveseat - Ash
Loveseat - Walnut

Core Code

ST01-02-A
ST01-02-W

Textile Yardage

Total: 8.25

List Price by Textile Grade*

	COM / 1	2	3	4	5	6	7	8	9	10	11	12	13	14	15
ST01-02-A	5976	6067	6191	6273	6364	6479	6620	6768	6941	7172	7445	7750	8179	8789	9400
ST01-02-W	7597	7688	7812	7894	7985	8100	8241	8389	8562	8793	9066	9371	9800	10410	11021

*Pricing assumes non-railroaded textiles. For railroaded pricing please contact us at info@memofurniture.com

Standard with Core Product

Non-Marring Glides
High Resilience Polyurethane Foam

Options

	Code	List Price Add
Clear Finish (by species)	WCA/WCW	0
Ash with Stain Finish	WOA/WWA	144

Specifiable Finishes

Textiles Choose from Camira, Maharam, or Kvadrat textiles on page 74, or contact Memo for assistance with COM fabrics
Wood Choose from Memo Wood Finishes on page 7

Notes

For step-by-step specifications and quotes, access our live quote tool online at → [Quotes](#)

Rolo

Sofa

Designed by Studio Tolvanen, 2021

Made in the USA.

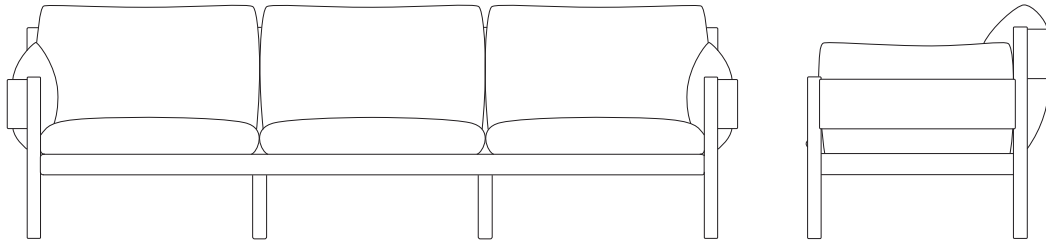

Depth	Width	Height
32"	94"	31"

Core Product

Sofa - Ash
Sofa - Walnut

Core Code

ST01-03-A
ST01-03-W

Textile Yardage

Total: 11.5

List Price by Textile Grade*

	COM / 1	2	3	4	5	6	7	8	9	10	11	12	13	14	15
ST01-03-A	8224	8351	8523	8638	8765	8926	9121	9328	9570	9892	10271	10697	11295	12146	12997
ST01-03-W	10294	10421	10593	10708	10835	10996	11191	11398	11640	11962	12341	12767	13365	14216	15067

*Pricing assumes non-railroaded textiles. For railroaded pricing please contact us at info@memofurniture.com

Standard with Core Product

Non-Marring Glides
High Resilience Polyurethane Foam

Options

	Code	List Price Add
Clear Finish (by species)	WCA/WCW	0
Ash with Stain Finish	WOA/WWA	168

Specifiable Finishes

Textiles Choose from Camira, Maharam, or Kvadrat textiles on page 74, or contact Memo for assistance with COM fabrics
Wood Choose from Memo Wood Finishes on page 7

Notes

For step-by-step specifications and quotes, access our live quote tool online at → [Quotes](#)

Rolo

Side Table

Designed by Studio Tolvanen, 2021

Made in the USA.

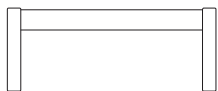
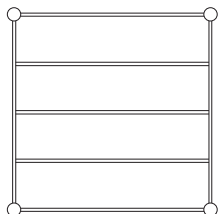

Depth	Width	Height
27.75"	27.75"	11"

Core Product	Core Code	List Price
Side Table - Ash	ST01-T1-A	1316
Side Table - Walnut	ST01-T1-W	1742

Standard with Core Product

Glides

Options

Specifiable Finishes

Choose from Memo Wood Finishes on page 7

	Code	List Price Add
Clear Finish (by species)	WCA/WCW	0
Ash with Stain Finish	WOA/WWA/WGA/WNP	123

Notes

For step-by-step specifications and quotes, access our live quote tool online at → [Quotes](#)

Rolo

Coffee Table

Designed by Studio Tolvanen, 2021

Made in the USA.

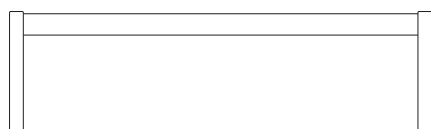
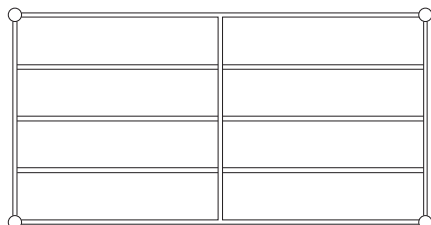

Depth	Width	Height
27.75"	53.75"	15"

Core Product	Core Code	List Price
Coffee Table - Ash	ST01-T2-A	1899
Coffee Table - Walnut	ST01-T2-W	2520

Standard with Core Product

Glides

Options

Specifiable Finishes

Choose from Memo Wood Finishes on page 7

	Code	List Price Add
Clear Finish (by species)	WCA/WCW	0
Ash with Stain Finish	WOA/WWA/WGA/WNP	134

Notes

For step-by-step specifications and quotes, access our live quote tool online at → [Quotes](#)

Textiles Graded-in sorted by pattern name **Camira**

Pattern Name	Group
Blazer	7
Carragan Flax	10
Era	2
Gravity	2
Main Line Flax	6
Oceanic	6
Quest	3
Rivet	2
Synergy	6

Textiles Graded-in sorted by pattern name **Maharam**

Article		
Article	458600	6
Beck	466570	10
Bluff	466489	9
Bright Angle	466331	13
Bright Cube	466329	13
Bright Grid	466330	13
Brindle	466418	8
Campana	466571	12
Chasm	466404	10
Darning Sampler Plaid	466462	14
Firma	466582	11
Flock	901892	7
Frequency	466504	10
Gemma	466568	11
Gemma Multi	466569	11
Jasper	466563	10
Lariat	440401	5
Ledger	463770	9
Manner	466177	5
Mantle	466517	7
Meld	466387	5
Merit	458600	6
Messenger	458640	5
Metaphor	466553	4
Metric	466014	5
Mode	466337	5
Murmur	466446	5
Muse	466487	3
Nico	466564	8
Pare	466359	10
Willow	466542	9

Textiles Graded-in sorted by pattern name **Kvadrat**

Pattern Name	Group
Canvas 2	10
Coda 2	14
Divina MD	11
Divina Melange 3	11
Fiord 2	12
Gentle 2 (Febrik)	15
Hallingdal 65	12
Herald 3	13
Melange Nap	10
Remix 3	8
Re-Wool	10
Steelcut 2	11
Steelcut Trio 3	11
Tonica 2	10
Vidar 4	15

Textiles Graded-in sorted by Grading Group: **Camira**

Group & Price/yard	Pattern Name
Group 1 48	
Group 2 59	Era
	Gravity
	Rivet
Group 3 74	Quest
Group 4 84	
Group 5 95	
Group 6 109	Main Line Flax
	Oceanic
	Synergy
Group 7 126	Blazer
Group 8 144	
Group 9 165	
Group 10 193	Craggan Flax

Textiles Graded-in sorted by Grading Group: **Kvadrat**

Group & Price/yard	Pattern Name
Group 1 48	
Group 2 59	
Group 3 74	
Group 4 84	
Group 5 95	
Group 6 109	
Group 7 126	
Group 8 144	Remix 3
Group 9 165	
Group 10 193	Canvas 2
	Melange Nap
	Re-wool
	Tonica 2
Group 11 228	Divina MD
	Divina Melange 3
	Steelcut 2
	Steelcut Trio 3
Group 12 263	Fiord 2
	Hallingdal 65
Group 13 315	Harald 3
Group 14 389	Coda 2
Group 15 463	Gentle 2 (Febrik)
	Vidar 4

Textiles Graded-in sorted by Grading Group: **Maharam**

Group & Price/yard	Pattern Name	Number
Group 1 48		
Group 2 59		
Group 3 74	Muse	466487
Group 4 84	Metaphor	466553
Group 5 95	Manner	466177
	Messenger	458640
	Metric	466014
	Murmur	466446
Group 6 109	Article	458600
	Merit	458600
Group 7 126	Flock	901892
	Mantle	466517
Group 8 144	Brindle	466418
	Nico	466564
Group 9 165	Bluff	466489
	Ledger	463770
	Willow	466542
Group 10 193	Beck	466570
	Chasm	466404
	Frequency	466504
	Jasper	466563
	Pare	466359
Group 11 228	Firma	466582
	Gemma	466568
	Gemma Multi	466569
Group 12 263	Campana	466571
Group 13 315	Bright Angle	466331
	Bright Cube	466329
	Bright Grid	466330
Group 14 389	Darning Sampler Plaid	466462

Corian Solid Surface Schedule sorted by Grading Group

Group 1	Abalone Bisque Bone Cameo White Glacier White Linen Maui Sahara Sandstone Silver Gray Vanilla	Group 4	Deep Caviar Deep Mink Deep Night Sky Dove Flint Fossil Granola Pine Raffia Rice Paper Royal Red Seafoam Serene Sage Suede Venaro White Whisper White Jasmine	Group 5	Whipped Cream Willow	Group 7	Minera Nimbus Prima Sagebrush Sand Storm Smoke Drift Prima Sonora Stardust White Onyx Windswept Prima
Group 2	Antarctica Aurora Blue Pebble Canyon Cocoa Brown Designer White Modern White Mojave Sand Savannah Stratus Summit White	Group 5	Anthracite Ash Concrete Blue Spice Carbon Concrete Cilantro Deep Anthracite Deep Bedrock Deep Cloud Deep Espresso Deep Nocturne Deep Sable Deep Space Deep Storm Deep Titanium Doeskin Fawn Glacier Ice Matterhorn Neutral Concrete Oat Silver Birch Silverite Weathered Concrete	Group 6	Arrowroot Basil Clam Shell Cool Gray Cosmos Prima Earth Gray Onyx Hazelnut Jasmine Keystone Lava Rock Limev Prima Natural Gray Rain Cloud Riverbed Rosemary Saffron Sandalwood Sorrel Tumbleweed Witch Hazel		
Group 3	Elegant Gray Everest Moss Nightfall Pearl Gray Platinum Silt Sparkling White			Group 7	Allspice Aqualite Burlled Beach Cocoa Prima Deep Inkwell Deep Lapis Deep Smoky Pear Deep Terrain Dune Prima Ecru Elderberry Evening Prima Graylite Hickory Smoke Juniper Milky Way		
Group 4	Arctic Ice Bronzite Canvas Cobalt Concrete Cottage Lane Deep Black Quartz						